

24" Planer

(Model 22-470, Three Phase)

INSTRUCTION MANUAL



PART NO. 1342457 06-03-05
Copyright © 2005 Delta Machinery

 **DELTA[®] INDUSTRIAL**

To learn more about DELTA MACHINERY
visit our website at: www.deltamachinery.com.

For Parts, Service, Warranty or other Assistance,

please call **1-800-223-7278** (In Canada call **1-800-463-3582**).

TABLE OF CONTENTS

IMPORTANT SAFETY INSTRUCTIONS2
SAFETY GUIDELINES3
GENERAL SAFETY RULES4
ADDITIONAL SPECIFIC SAFETY RULES5
FUNCTIONAL DESCRIPTION6
CARTON CONTENTS7
ASSEMBLY8
OPERATION11
TROUBLESHOOTING23
MAINTENANCE23
SERVICE24
ACCESSORIES24
WARRANTY25
SERVICE CENTER LOCATIONSback cover

IMPORTANT SAFETY INSTRUCTIONS

▲ WARNING Read and understand all warnings and operating instructions before using any tool or equipment. When using tools or equipment, basic safety precautions should always be followed to reduce the risk of personal injury. Improper operation, maintenance or modification of tools or equipment could result in serious injury and property damage. There are certain applications for which tools and equipment are designed. Delta Machinery strongly recommends that this product NOT be modified and/or used for any application other than for which it was designed.

If you have any questions relative to its application DO NOT use the product until you have written Delta Machinery and we have advised you.

Online contact form at www.deltamachinery.com

Postal Mail: Technical Service Manager
Delta Machinery
4825 Highway 45 North
Jackson, TN 38305

(IN CANADA: 125 Mural St. Suite 300, Richmond Hill, ON, L4B 1M4)

Information regarding the safe and proper operation of this tool is available from the following sources:

Power Tool Institute
1300 Sumner Avenue, Cleveland, OH 44115-2851
www.powertoolinstitute.org

National Safety Council
1121 Spring Lake Drive, Itasca, IL 60143-3201

American National Standards Institute, 25 West 43rd Street, 4 floor, New York, NY 10036 www.ansi.org
ANSI 01.1 Safety Requirements for Woodworking Machines, and

the U.S. Department of Labor regulations www.osha.gov

SAVE THESE INSTRUCTIONS!

SAFETY GUIDELINES - DEFINITIONS

It is important for you to read and understand this manual. The information it contains relates to protecting YOUR SAFETY and PREVENTING PROBLEMS. The symbols below are used to help you recognize this information.



- ▲ DANGER** Indicates an imminently hazardous situation which, if not avoided, will result in death or serious injury.
- ▲ WARNING** Indicates a potentially hazardous situation which, if not avoided, could result in death or serious injury.
- ▲ CAUTION** Indicates a potentially hazardous situation which, if not avoided, may result in minor or moderate injury.
- CAUTION** Used without the safety alert symbol indicates potentially hazardous situation which, if not avoided, may result in property damage.

CALIFORNIA PROPOSITION 65

▲ WARNING **SOME DUST CREATED BY POWER SANDING, SAWING, GRINDING, DRILLING, AND OTHER CONSTRUCTION ACTIVITIES** contains chemicals known to cause cancer, birth defects or other reproductive harm.

Some examples of these chemicals are:

- lead from lead-based paints,
- crystalline silica from bricks and cement and other masonry products, and
- arsenic and chromium from chemically-treated lumber.

Your risk from these exposures varies, depending on how often you do this type of work. To reduce your exposure to these chemicals: work in a well ventilated area, and work with approved safety equipment, always wear **NIOSH/OSHA** approved, properly fitting face mask or respirator when using such tools.

GENERAL SAFETY RULES



▲ WARNING READ AND UNDERSTAND ALL WARNINGS AND OPERATING INSTRUCTIONS BEFORE USING THIS EQUIPMENT. Failure to follow all instructions listed below, may result in electric shock, fire, and/or serious personal injury or property damage.

IMPORTANT SAFETY INSTRUCTIONS

- 1. FOR YOUR OWN SAFETY, READ THE INSTRUCTION MANUAL BEFORE OPERATING THE MACHINE.** Learning the machine's application, limitations, and specific hazards will greatly minimize the possibility of accidents and injury.
- 2. WEAR EYE AND HEARING PROTECTION. ALWAYS USE SAFETY GLASSES.** Everyday eyeglasses are NOT safety glasses. USE CERTIFIED SAFETY EQUIPMENT. Eye protection equipment should comply with ANSI Z87.1 standards. Hearing equipment should comply with ANSI S3.19 standards.
- 3. WEAR PROPER APPAREL.** Do not wear loose clothing, gloves, neckties, rings, bracelets, or other jewelry which may get caught in moving parts. Nonslip footwear is recommended. Wear protective hair covering to contain long hair.
- 4. DO NOT USE THE MACHINE IN A DANGEROUS ENVIRONMENT.** The use of power tools in damp or wet locations or in rain can cause shock or electrocution. Keep your work area well-lit to prevent tripping or placing arms, hands, and fingers in danger.
- 5. MAINTAIN ALL TOOLS AND MACHINES IN PEAK CONDITION.** Keep tools sharp and clean for best and safest performance. Follow instructions for lubricating and changing accessories. Poorly maintained tools and machines can further damage the tool or machine and/or cause injury.
- 6. CHECK FOR DAMAGED PARTS.** Before using the machine, check for any damaged parts. Check for alignment of moving parts, binding of moving parts, breakage of parts, and any other conditions that may affect its operation. A guard or any other part that is damaged **should be properly repaired or replaced.** Damaged parts can cause further damage to the machine and/or injury.
- 7. KEEP THE WORK AREA CLEAN.** Cluttered areas and benches invite accidents.
- 8. KEEP CHILDREN AND VISITORS AWAY.** Your shop is a potentially dangerous environment. Children and visitors can be injured.
- 9. REDUCE THE RISK OF UNINTENTIONAL STARTING.** Make sure that the switch is in the "OFF" position before plugging in the power cord. In the event of a power failure, move the switch to the "OFF" position. An accidental start-up can cause injury.
- 10. USE THE GUARDS.** Check to see that all guards are in place, secured, and working correctly to reduce the risk of injury.
- 11. REMOVE ADJUSTING KEYS AND WRENCHES BEFORE STARTING THE MACHINE.** Tools, scrap pieces, and other debris can be thrown at high speed, causing injury.
- 12. USE THE RIGHT MACHINE.** Don't force a machine or an attachment to do a job for which it was not designed. Damage to the machine and/or injury may result.
- 13. USE RECOMMENDED ACCESSORIES.** The use of accessories and attachments not recommended by Delta may cause damage to the machine or injury to the user.
- 14. USE THE PROPER EXTENSION CORD.** Make sure your extension cord is in good condition. When using an extension cord, be sure to use one heavy enough to carry the current your product will draw. An undersized cord will cause a drop in line voltage, resulting in loss of power and overheating. See the Extension Cord Chart for the correct size depending on the cord length and nameplate ampere rating. If in doubt, use the next heavier gauge. The smaller the gauge number, the heavier the cord.
- 15. SECURE THE WORKPIECE.** Use clamps or a vise to hold the workpiece when practical. Loss of control of a workpiece can cause injury.
- 16. FEED THE WORKPIECE AGAINST THE DIRECTION OF THE ROTATION OF THE BLADE, CUTTER, OR ABRASIVE SURFACE.** Feeding it from the other direction will cause the workpiece to be thrown out at high speed.
- 17. DON'T FORCE THE WORKPIECE ON THE MACHINE.** Damage to the machine and/or injury may result.
- 18. DON'T OVERREACH.** Loss of balance can make you fall into a working machine, causing injury.
- 19. NEVER STAND ON THE MACHINE.** Injury could occur if the tool tips, or if you accidentally contact the cutting tool.
- 20. NEVER LEAVE THE MACHINE RUNNING UNATTENDED. TURN THE POWER OFF.** Don't leave the machine until it comes to a complete stop. A child or visitor could be injured.
- 21. TURN THE MACHINE "OFF", AND DISCONNECT THE MACHINE FROM THE POWER SOURCE** before installing or removing accessories, before adjusting or changing set-ups, or when making repairs. An accidental start-up can cause injury.
- 22. MAKE YOUR WORKSHOP CHILDPROOF WITH PADLOCKS, MASTER SWITCHES, OR BY REMOVING STARTER KEYS.** The accidental start-up of a machine by a child or visitor could cause injury.
- 23. STAY ALERT, WATCH WHAT YOU ARE DOING, AND USE COMMON SENSE. DO NOT USE THE MACHINE WHEN YOU ARE TIRED OR UNDER THE INFLUENCE OF DRUGS, ALCOHOL, OR MEDICATION.** A moment of inattention while operating power tools may result in injury.
- 24. ▲ WARNING USE OF THIS TOOL CAN GENERATE AND DISBURSE DUST OR OTHER AIRBORNE PARTICLES, INCLUDING WOOD DUST, CRYSTALLINE SILICA DUST AND ASBESTOS DUST.** Direct particles away from face and body. Always operate tool in well ventilated area and provide for proper dust removal. Use dust collection system wherever possible. Exposure to the dust may cause serious and permanent respiratory or other injury, including silicosis (a serious lung disease), cancer, and death. Avoid breathing the dust, and avoid prolonged contact with dust. Allowing dust to get into your mouth or eyes, or lay on your skin may promote absorption of harmful material. Always use properly fitting NIOSH/OSHA approved respiratory protection appropriate for the dust exposure, and wash exposed areas with soap and water.

ADDITIONAL SPECIFIC SAFETY RULES

▲ WARNING

FAILURE TO FOLLOW THESE RULES MAY RESULT IN SERIOUS INJURY.

1. **DO NOT OPERATE THIS MACHINE** until it is completely assembled and installed according to the instructions. A machine incorrectly assembled can cause serious injury.
2. **OBTAIN ADVICE** from your supervisor, instructor, or another qualified person if you are not thoroughly familiar with the operation of this machine. Knowledge is safety.
3. **FOLLOW ALL WIRING CODES** and recommend electrical connections to prevent shock or electrocution.
4. **KEEP KNIVES SHARP** and free from rust and pitch. Dull or rusted knives work harder and can cause kickback.
5. **NEVER TURN THE MACHINE “ON”** before clearing the table of all objects (tools, scraps of wood, etc.). Flying debris can cause serious injury.
6. **NEVER TURN THE MACHINE “ON”** with the workpiece contacting the cutterhead. Kickback can occur.
7. **SECURE THE MACHINE TO A SUPPORTING SURFACE** to prevent the machine from sliding, walking or tipping over.
8. **PROPERLY SECURE THE KNIVES IN THE CUTTERHEAD** before turning the power “ON”. Loose blades may be thrown out at high speeds causing serious injury.
9. **LOCK THE SPEED SETTING SECURELY** before feeding the workpiece through the machine. Changing speeds while planing can cause kick-back.
10. **AVOID AWKWARD OPERATIONS AND HAND POSITIONS.** A sudden slip could cause a hand to move into the knives.
11. **KEEP ARMS, HANDS, AND FINGERS** away from the cutterhead, the chip exhaust opening, and the feed rollers to prevent severe cuts.
12. **NEVER REACH INTO THE CUTTERHEAD AREA** while the machine is running. Your hands can be drawn into the knives.
13. **DO NOT STAND IN LINE OF THE WORKPIECE.** Kickback can cause injury.
14. **ALLOW THE CUTTERHEAD TO REACH FULL SPEED** before feeding a workpiece. Changing speeds while planing can cause kickback.
15. **WHEN PLANING BOWED STOCK,** place the concave (cup down) side of the stock on the table and cut with the grain to prevent kickback.
16. **DO NOT FEED A WORKPIECE** that is warped, contains knots, or is embedded with foreign objects (nails, staples, etc.). Kickback can occur.
17. **DO NOT FEED A SHORT, THIN, OR NARROW WORKPIECE INTO THE MACHINE.** Your hands can be drawn into the knives and/or the workpiece can be thrown at high speeds. See the “OPERATION” section of this instruction manual for details.
18. **DO NOT FEED A WORKPIECE** into the outfeed end of the machine. The workpiece will be thrown out of the opposite side at high speeds.
19. **REMOVE SHAVINGS ONLY** with the power “OFF” to prevent serious injury.
20. **PROPERLY SUPPORT LONG OR WIDE WORKPIECES.** Loss of control of the workpiece can cause serious injury.
21. **NEVER PERFORM LAYOUT, ASSEMBLY** or set-up work on the table/work area when the machine is running. Serious injury will result.
22. **TURN THE MACHINE “OFF”, DISCONNECT IT FROM THE POWER SOURCE,** and clean the table/work area before leaving the machine. **LOCK THE SWITCH IN THE “OFF” POSITION** to prevent unauthorized use. Someone else might accidentally start the machine and cause injury to themselves or others.
23. **ADDITIONAL INFORMATION** regarding the safe and proper operation of power tools (i.e. a safety video) is available from the Power Tool Institute, 1300 Sumner Avenue, Cleveland, OH 44115-2851 (www.powertoolinstitute.com). Information is also available from the National Safety Council, 1121 Spring Lake Drive, Itasca, IL 60143-3201. Please refer to the American National Standards Institute ANSI 01.1 Safety Requirements for Woodworking Machines and the U.S. Department of Labor Regulations.

SAVE THESE INSTRUCTIONS.

Refer to them often and use them to instruct others.

POWER CONNECTIONS

A separate electrical circuit should be used for your machines. This circuit should not be less than #12 wire and should be protected with a 20 Amp time lag fuse. If an extension cord is used, use only 3-wire extension cords which have 3-prong grounding type plugs and matching receptacle which will accept the machine's plug. Before connecting the machine to the power line, make sure the switch (s) is in the "OFF" position and be sure that the electric current is of the same characteristics as indicated on the machine. All line connections should make good contact. Running on low voltage will damage the machine.

⚠ DANGER DO NOT EXPOSE THE MACHINE TO RAIN OR OPERATE THE MACHINE IN DAMP LOCATIONS.

MOTOR SPECIFICATIONS

The 22-470 has a 7½ HP three phase engine that comes wired at 220 volts and 60 HZ alternating current. The motor is also capable of being wired for 440 volt operation, but this connection must be done by a qualified electrician and conform to the National Electric Code and all local codes and ordinances.

GROUNDING INSTRUCTIONS

⚠ DANGER THIS MACHINE MUST BE GROUNDED WHILE IN USE TO PROTECT THE OPERATOR FROM ELECTRIC SHOCK.

These machines are not supplied with power cords and they are intended to be permanently connected to the building's electrical system. All wiring must be done by a qualified electrician and conform to the National Electric Code and all local codes and ordinances. For wiring instructions, see section "WIRING THE MACHINE" in this manual.

LVC MAGNETIC MOTOR CONTROL: If you purchased a machine that has a Low Voltage Magnetic Motor Control System, refer to its instruction manual for installation guidance.

FUNCTIONAL DESCRIPTION

FOREWORD

The Delta Industrial Model 22-470 is a 24" Planer with a 7½ HP, three-phase motor capable of 220 volt or 440 volt operation with an LVC magnetic starter and automatic reset overload protection; 3-knife cutterhead, sectional serrated infeed roll, double bed rolls and polyurethane outfeed roll, sectional chipbreakers, dust chute, knife-setting gage and wrench.

NOTICE: THE PHOTO ON THE MANUAL COVER ILLUSTRATES THE CURRENT PRODUCTION MODEL. ALL OTHER ILLUSTRATIONS CONTAINED IN THE MANUAL ARE REPRESENTATIVE ONLY AND MAY NOT DEPICT THE ACTUAL COLOR, LABELING OR ACCESSORIES AND ARE INTENDED TO ILLUSTRATE TECHNIQUE ONLY.

CARTON CONTENTS

The 22-470 planer is shipped complete in one container mounted to a shipping skid. Remove the wooden crate from around the machine. The planer is shipped with the motor, motor pulleys and belts assembled to the machine. Fig. 2, illustrates the loose items supplied with the machine.

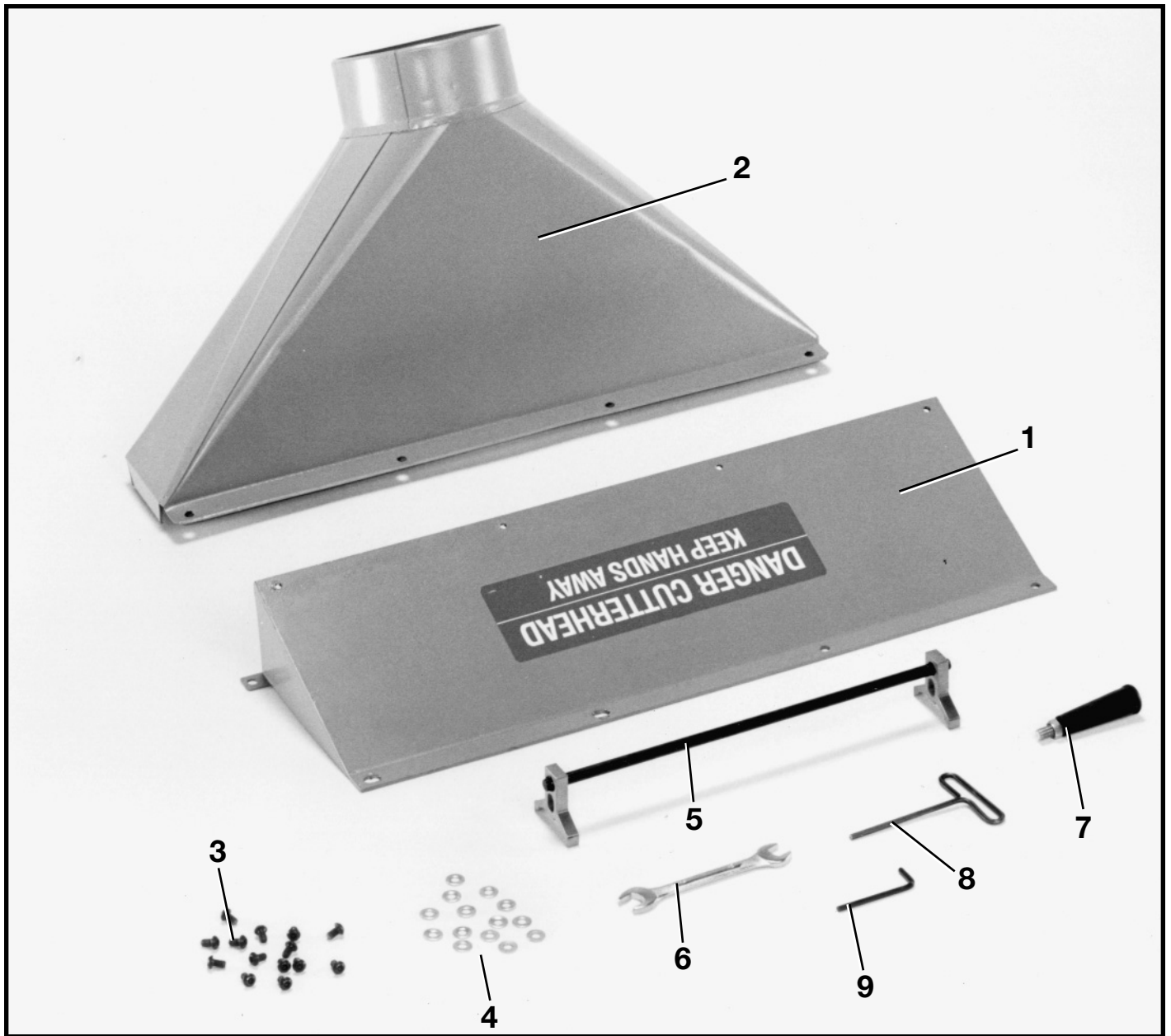

Fig. 2

- | | | |
|--------------------------------------|------------------------------|---------------------|
| 1. Cutterhead Guard | 4. Flat Washers (14) | 7. Handwheel handle |
| 2. Dust Hood | 5. Knife setting gage | 8. T-handle wrench |
| 3. M6 x 12mm Button-head Screws (14) | 6. 10 x 14mm open end wrench | 9. Allen wrench |

UNPACKING AND CLEANING

Carefully unpack the machine and all loose items from the shipping container(s). Remove the protective coating from all unpainted surfaces. This coating may be removed with a soft cloth moistened with kerosene (do not use acetone, gasoline or lacquer thinner for this purpose). After cleaning, cover the unpainted surfaces with a good quality household floor paste wax.

ASSEMBLY

ASSEMBLY TOOLS REQUIRED

- * M6 Allen wrench (supplied) * Flathead Screwdriver (Not Supplied)
- * Forklift and Lifting Straps For Set-Up (Not Supplied)

ASSEMBLY TIME ESTIMATE - 1-2 hours

UNPACKING AND CLEANING

Remove the bolts that fasten the machine to the shipping skid.

Two lifting lugs are built into the machine, one of which is shown at (A) Fig. 4. These lugs can be used to mechanically lift the machine using a forklift and lifting straps. **NOTE:** The other lifting lug is located at the rear and the opposite end of the machine. Carefully remove the planer from the shipping skid.

Thread handle assembly (A) Fig. 3, into handwheel (B) and tighten locknut (C).

If it is necessary to lower the table (B) Fig. 4, to facilitate cleaning, loosen lock knob (C) and turn handwheel (D) counterclockwise until the table (B) is at the desired height for cleaning.

With allen wrench supplied, loosen and remove screw (E) Fig. 5, from the left top edge of the machine and raise the top cover (F) Fig. 6 as shown, exposing the chip-breakers, and cutterhead. **NOTE:** The top cover of the machine is hinged to facilitate cleaning and performing maintenance and adjustment procedures.

Carefully remove the protective coating from the table, table rollers, infeed roller, anti-kickback fingers, cutterhead and cutterhead knives. This protective coating may be removed with a soft cloth moistened with kerosene. **(DO NOT USE GASOLINE, ACETONE, OR LACQUER THINNER FOR THIS PURPOSE).** **CAUTION:** Extreme care should be taken when cleaning the knives as the cutterhead knives are positioned in the cutterhead and are very sharp.

After cleaning, cover the table surface with a good quality paste wax.

Lower top cover and replace locking screw which was removed in **STEP 5**.

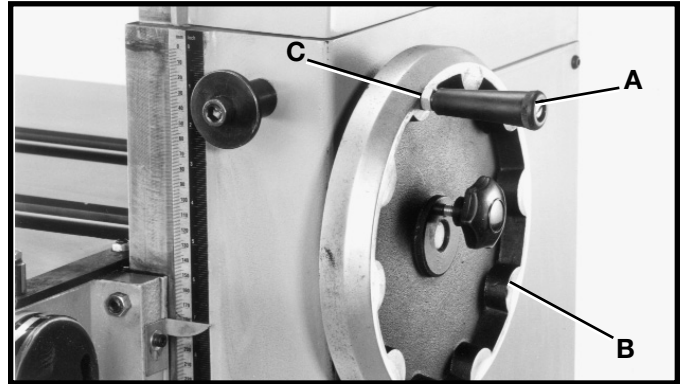

Fig. 3

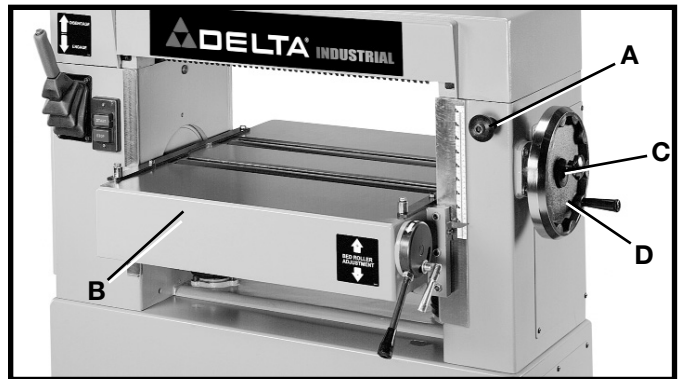

Fig. 4

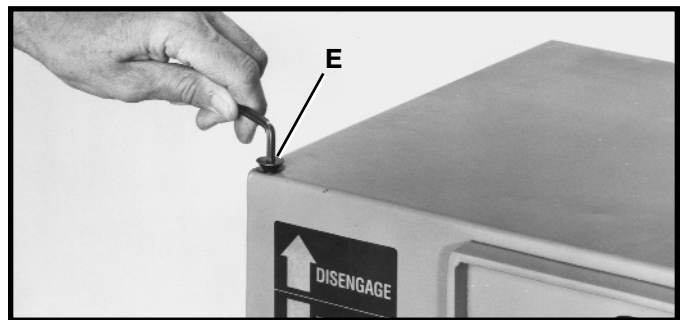

Fig. 5

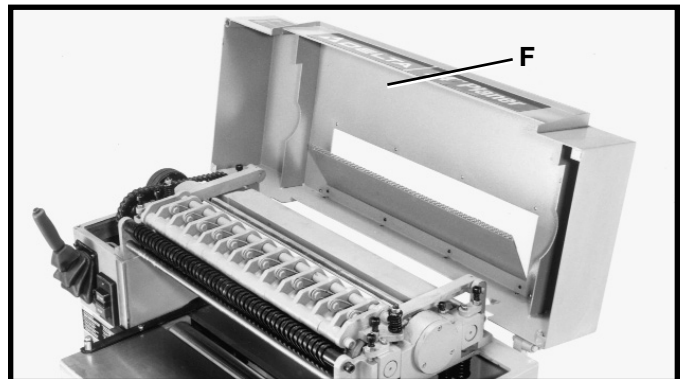

Fig. 6

ASSEMBLING CUTTERHEAD GUARD

Position cutterhead guard (A) Fig. 7, on top cover of machine. Align holes in cutterhead guard (A) Fig. 7, with holes in top cover and fasten with six 12mm button head screws (B) and flat washers, five of which are shown.

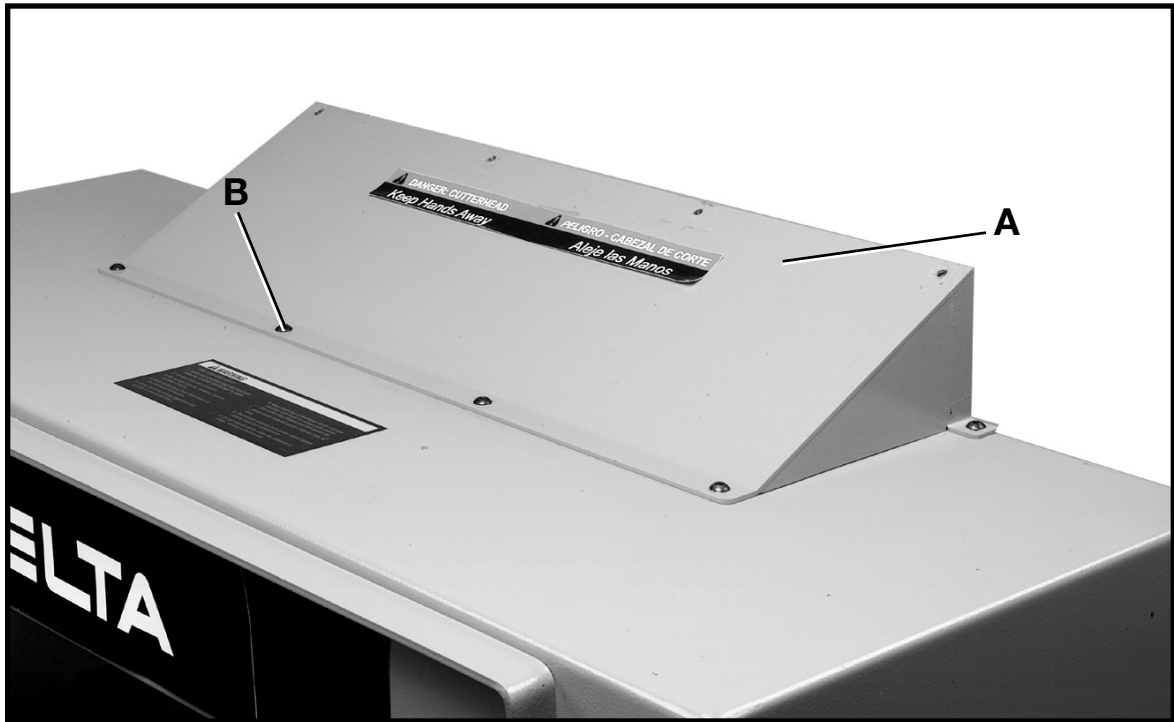

Fig. 7

ASSEMBLING DUST HOOD

A dust hood with a 5-inch opening is supplied with your machine and is to be used when connecting the planer to a dust collector or a central dust collection system.

Position dust hood (A) Fig. 8, against the rear of the machine and on top of cutterhead guard (B). Align the holes and fasten the dust hood (A) Fig. 9, to the cutterhead guard (B) using seven 12mm button head screws (C) and flat washers, four of which are shown.

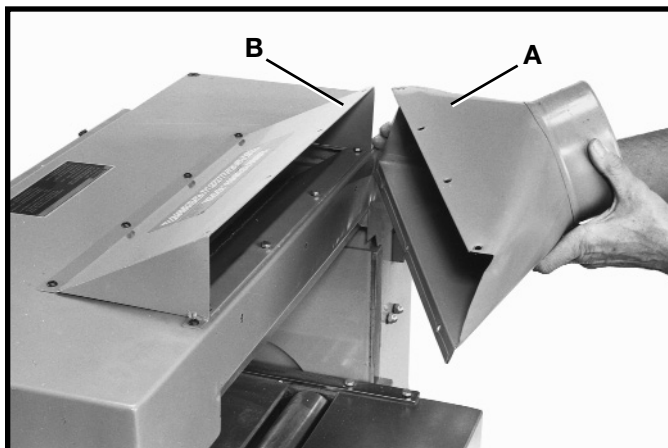

Fig. 8

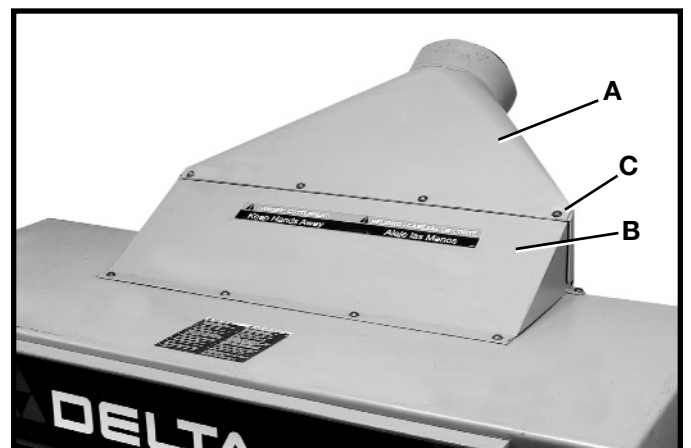

Fig. 9

ELECTRICAL CONNECTIONS

The planer comes wired for 220 volt operation, but it can be wired for 440 volts. Before connecting your machine to an electrical power system, make certain the motor rating agrees with the electrical system it is to be connected to.

NOTE: All electrical connections should be done by a qualified electrician and conform to the National Electric Code and all local codes and ordinances.

NOTE: Power cord and plug are not shipped with the planer. The standard machine is shipped wired for 220 volt operation. To wire the machine:

1. Loosen screw (A) Fig. 10, and remove cover (B) from terminal box located at the rear of the machine. Bring power line up through hole (C) Fig. 11, in the terminal box. **NOTE:** Strain relief and power cord clamp are not supplied with the machine. Remove plastic shield (D) Fig. 11, from terminal strip (E).
2. Connect the three power lines to terminals (F), (G), and (K) Fig. 12, and the green ground wire to terminal (H). After applying power to the machine, jog the power on and off to check if the machine is rotating correctly. If the cutterhead is not rotating correctly, interchange any two of the three power lines connected to terminals (F), (G), and (K).

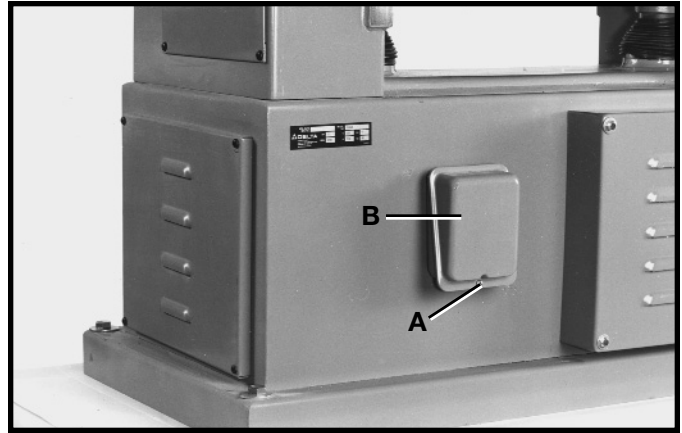

Fig. 10

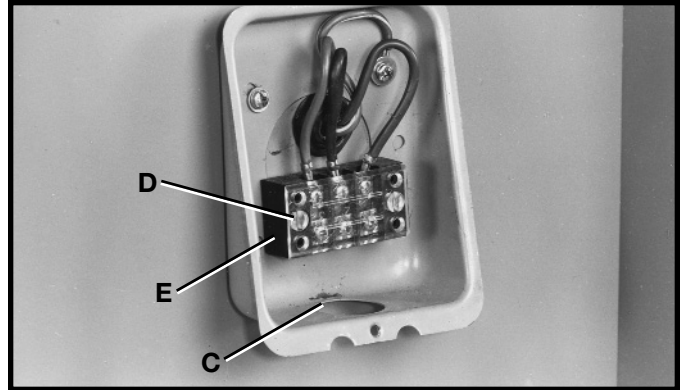

Fig. 11

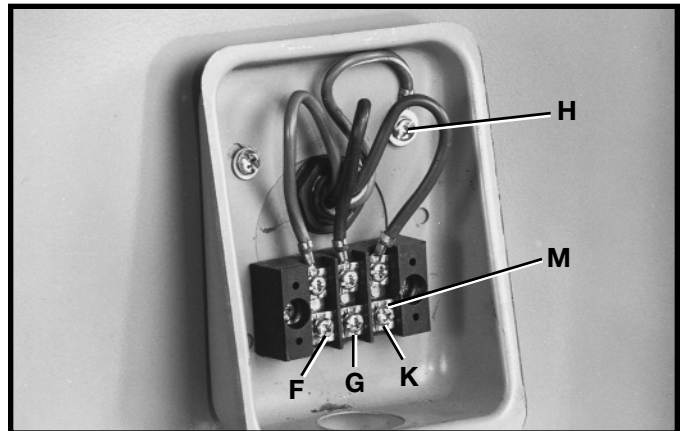

Fig. 12

OPERATION

OPERATIONAL CONTROLS AND ADJUSTMENTS

STARTING AND STOPPING THE PLANER

1. The power switch (A) Fig. 13 is located on the front of the planer. To turn the machine on, push the "START" button.
2. To turn the machine "OFF", push the stop button (B).



Fig. 13

LOCKING SWITCH IN "OFF" POSITION

IMPORTANT: When the machine is not in use, the switch should be locked in the "OFF" position to prevent unauthorized use, using a padlock (C) Fig. 14 with a 3/16" diameter shackle.

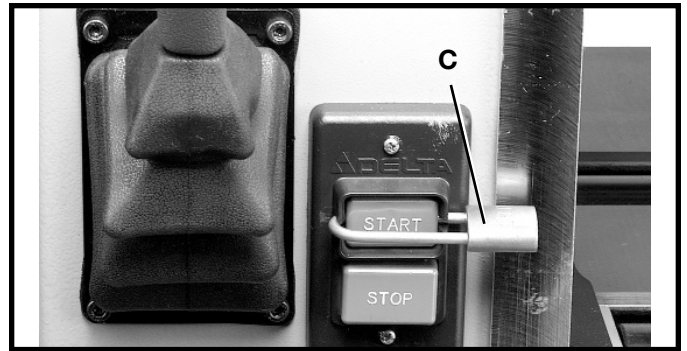

Fig. 14

RAISING AND LOWERING THE TABLE

Adjust the table height by loosening lock knob (A) Fig. 15, and rotating table adjusting handwheel (B). To raise the table, turn handwheel (B) clockwise; to lower the table, turn handwheel (B) counterclockwise. Tighten lock knob (A) Fig. 15, after table height adjustment is made. The English/Metric table height scale (C) Fig. 15, indicates the table height setting. **IMPORTANT:** For best results, setting of the table should always be made from the bottom to the up position.

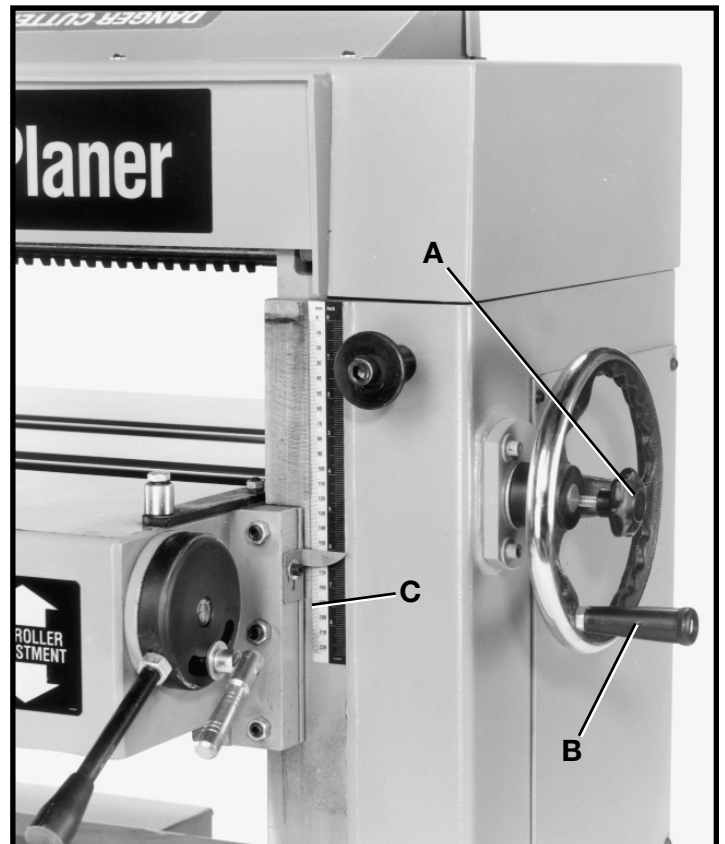

Fig. 15

FEED ROLLER SPEEDS

Your planer is equipped with feed roller speeds of 20 and 30 feet per minute depending on belt placement on the pulleys. As a rule, a faster feed rate is used for general planing operations, while a slower feed rate (because it provides more cuts per inch of stock) gives a finer and smoother finish to the workpiece.

1. To engage the feed rollers, simultaneously push button (A) Fig. 16, and pull downward on handle (B).
2. To disengage the feed rollers, simultaneously push button (A) Fig. 17, and move handle (B) to the raised position, as shown.
3. To change feed roller speeds, disengage the feed rollers as explained in **STEP 2**.
4. **⚠ WARNING DISCONNECT THE MACHINE FROM THE POWER SOURCE.**
5. Open two doors (C) and (D) Fig. 18, located on the left side of the machine.

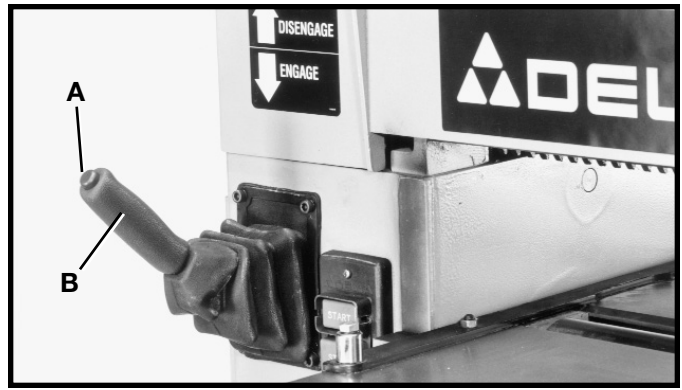

Fig. 16



Fig. 17

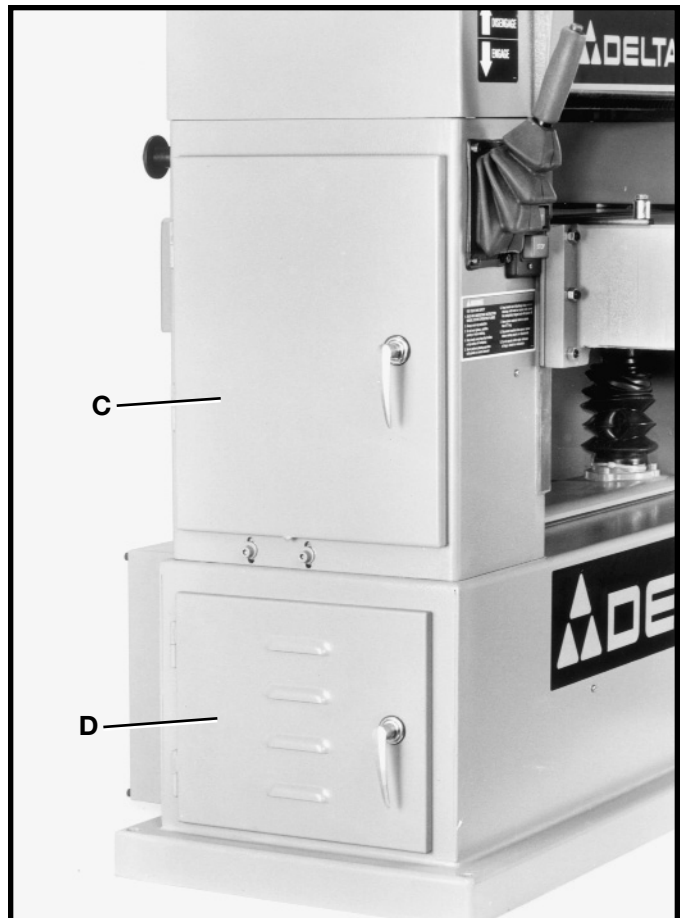

Fig. 18

6. Reposition drive belt (E) Fig. 19, on pulleys (F) and (G). When belt (E) Fig. 19, is on the smallest step of motor pulley (G) and the largest step of the gear box pulley (F), the feed roller speed will be 20 feet per minute. When belt (E) Fig. 19, is on the largest step of the motor pulley (G) and the smallest step of gear box pulley (F), the feed roller speed will be 30 feet per minute. A feed rate adjustment chart is located on the back of panel (C) Fig. 20, for quick reference.

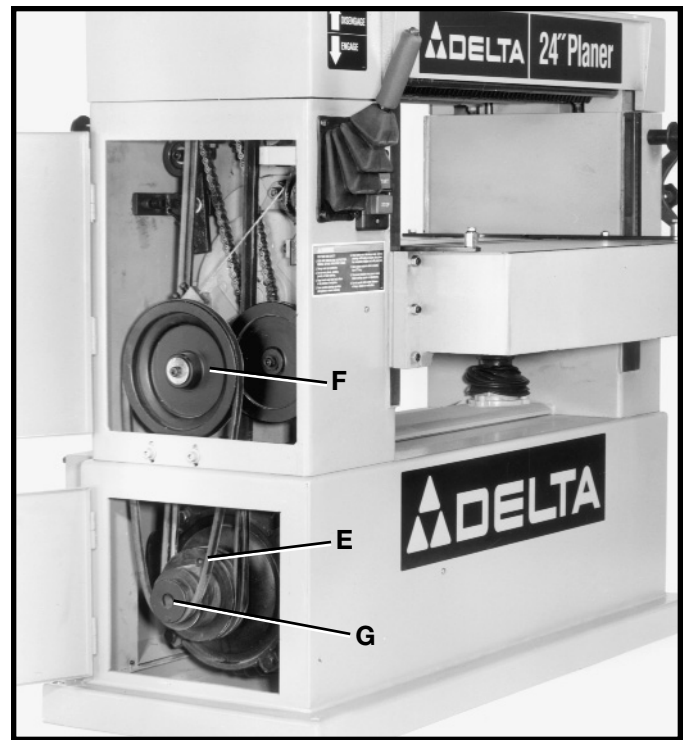

Fig. 19



Fig. 20

TABLE ROLLERS

Your planer is supplied with two table rollers (A) Fig. 21, which aid in feeding the stock by reducing friction between the stock and the table and rotate as the stock is fed through the planer.

1. To raise the table rollers, loosen locking lever (B) Fig. 21, and pull control lever (C) upward to the desired height setting.
2. To lower the table rollers, loosen locking lever (B) Fig. 21, and push control lever (C) downward to the desired height setting.
3. After adjusting height of the table rollers, tighten locking lever (B) Fig. 21.



Fig. 21

CHECKING AND ADJUSTING TABLE ROLLER HEIGHT

It is not possible to give exact dimensions on the proper height setting of the table rollers because each type of wood has different behavioral patterns. As a general rule, when planing rough stock, the table rollers should be set high (.003 to .005) above the table surface. When planing finish stock, the table rollers should be set low (.001) above or level with the table surface. To check and adjust the height of the table rollers, proceed as follows:

1. **⚠ WARNING DISCONNECT THE MACHINE FROM THE POWER SOURCE.**
2. With the table rollers in the lowest position, lay a straight edge (A) Fig. 22, across both table rollers (B) on the left side of the table as shown.
3. With a feeler gage Fig. 23, measure the gap between the table surface and the straight edge (A) near the infeed roller (C).
4. If an adjustment to the infeed table roller is necessary, loosen locknut (D) Fig. 24, which is located under the table and below the infeed roller and rotate adjustment nuts (E) as necessary to raise or lower the height of the infeed roller. **NOTE:** It will be necessary to raise the table to gain access to the adjustment nuts. Tighten locknut (D) after adjustment is made.
5. Check and adjust the height of the infeed table roller on the other side of the table in the same manner.
6. To check the height of the outfeed table roller, proceed as follows: with a feeler gage (B) Fig. 25, measure the gap between the table surface and the straight edge (A) near the outfeed roller (F).

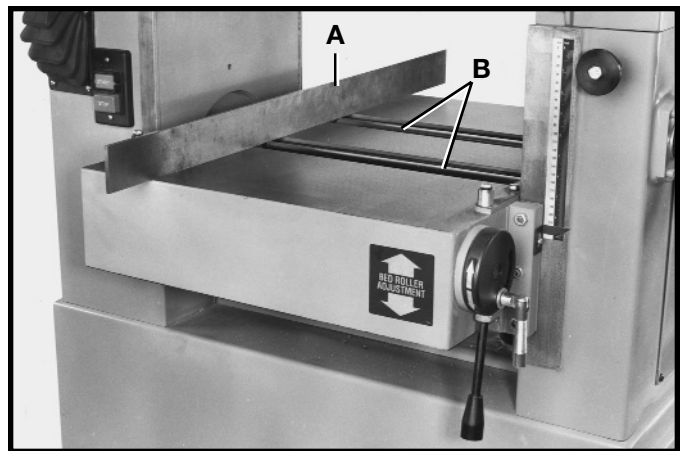

Fig. 22

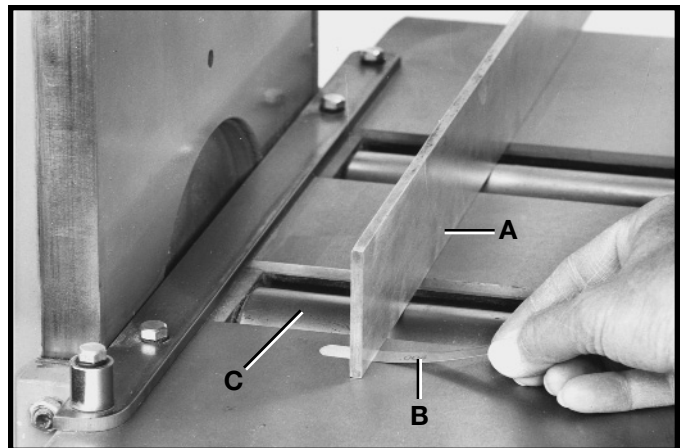

Fig. 23

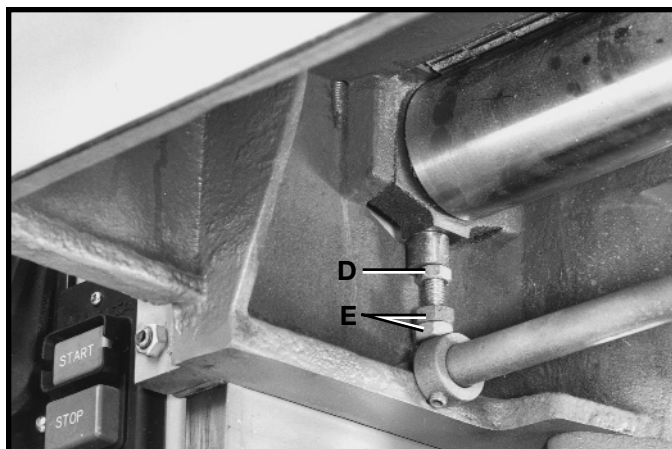

Fig. 24

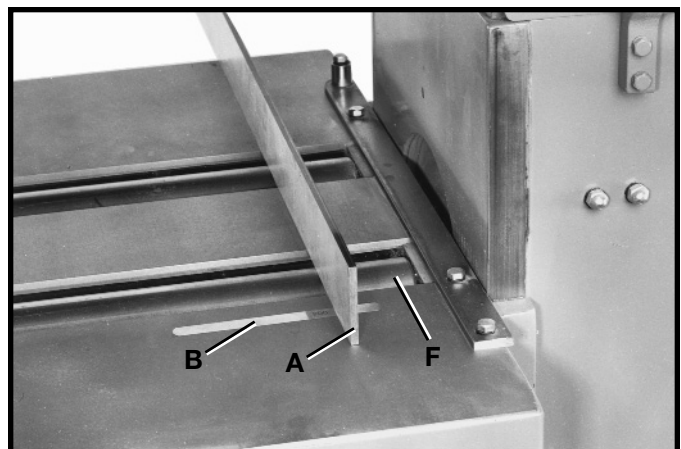

Fig. 25

- If an adjustment to the outfeed table roller is necessary, loosen locknut (G) Fig. 26, which is located under the table and below the outfeed table roller (F), and rotate adjustment nuts (H) as necessary, to raise or lower the height of the outfeed roller (F). **NOTE:** It will be necessary to raise the table to gain access to the adjustment nuts. Tighten locknut (G) Fig. 26, after the adjustment is made.
- Check and adjust the height of the outfeed table roller on the other side of the table in the same manner.

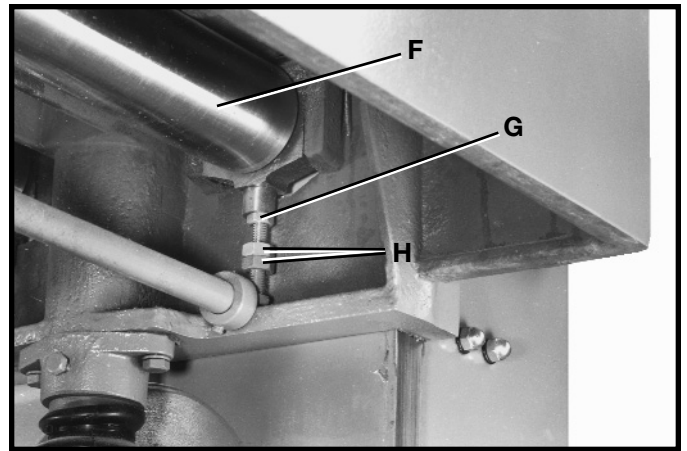

Fig. 26

ANTI-KICKBACK FINGERS

A series of anti-kickback fingers (A) Fig. 27, are provided on the infeed end of the planer to prevent kickback of the workpiece during planing operations. These anti-kickback fingers operate by gravity and no adjustment is required. It is necessary, however, to inspect them occasionally to make sure they are free of gum and pitch and that they operate independently and freely.

⚠ WARNING WHEN INSPECTING AND CLEANING THE ANTI-KICKBACK FINGERS, MAKE CERTAIN THE MACHINE IS DISCONNECTED FROM THE POWER SOURCE.

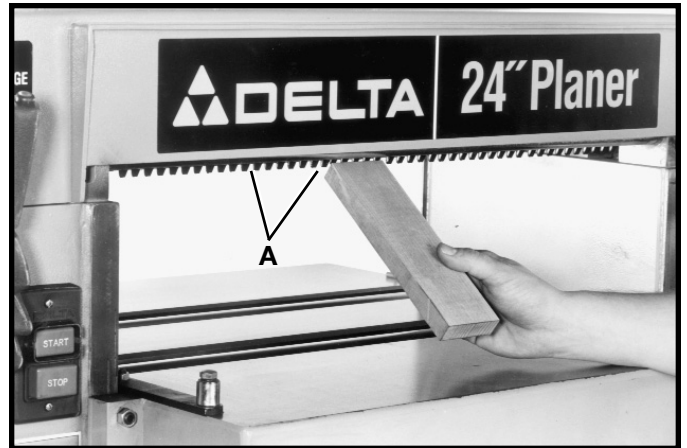

Fig. 27

CHECKING AND ADJUSTING DRIVE BELT TENSION

Proper belt tension is when there is approximately $\frac{1}{4}$ \"/>

- ⚠ WARNING** DISCONNECT THE MACHINE FROM THE POWER SOURCE.
- Disengage feed roller lever (B) Fig. 28.

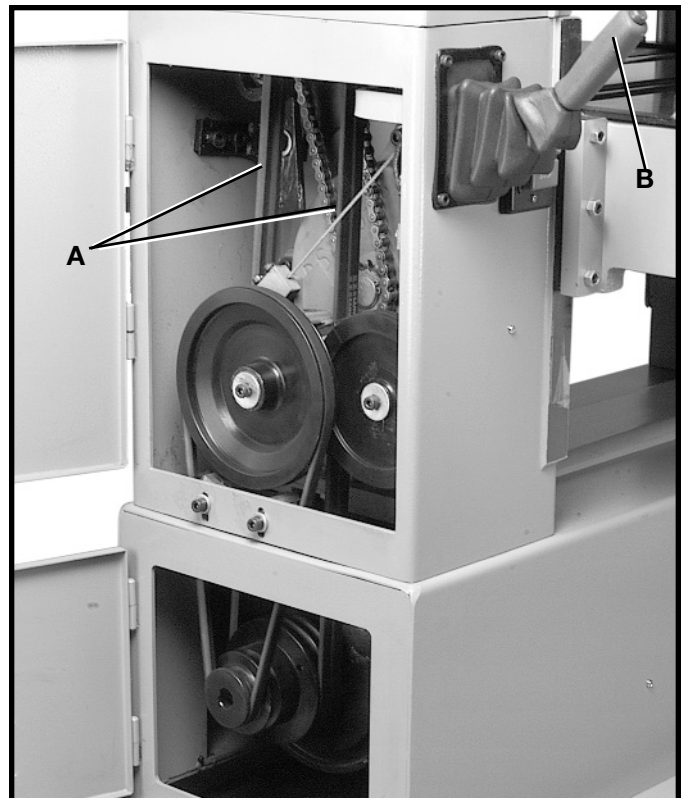

Fig. 28

- Loosen and tighten two adjustment nuts (C) Fig. 29, to move motor plate up or down as necessary to increase or decrease drive belt tension. Tighten both adjustment nuts (C) against plate (D) Fig. 29, after adjustment is made.
- Close both side panels.

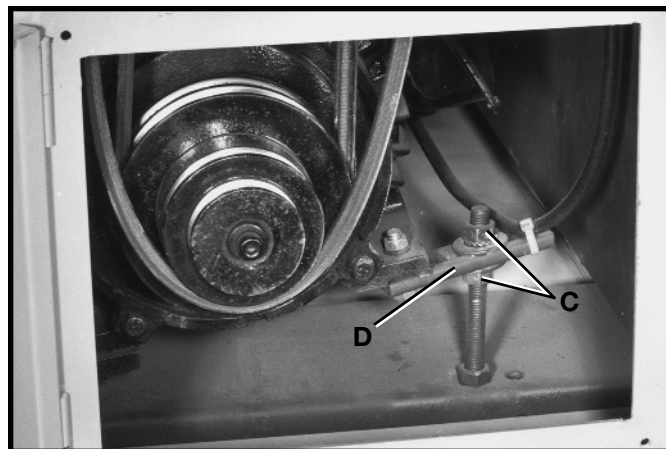

Fig. 29

CHECKING AND ADJUSTING FEED ROLLER BELT TENSION

Proper tension on the feed roller belt is obtained when there is approximately 1/2 deflection, using light finger pressure on feed roller belt (A) Fig. 30. midway between pulleys (B) and (C), with feed roller lever (D) engaged. If an adjustment is necessary, proceed as follows:

- ⚠ WARNING DISCONNECT THE MACHINE FROM THE POWER SOURCE.**
- Engage feed roller lever (D) Fig. 30.
- Remove four screws (E) Fig. 31, which hold engagement lever boot (F) to the machine.
- Raise boot (F) Fig. 32, to gain access to adjustment hardware.
- Loosen jam nut (G) Fig. 32, and tighten or loosen adjustment hex nut (H) as necessary to adjust feed roller belt tension.
- Tighten jam nut (G) Fig. 32, against hex nut (H) after adjustment is made.

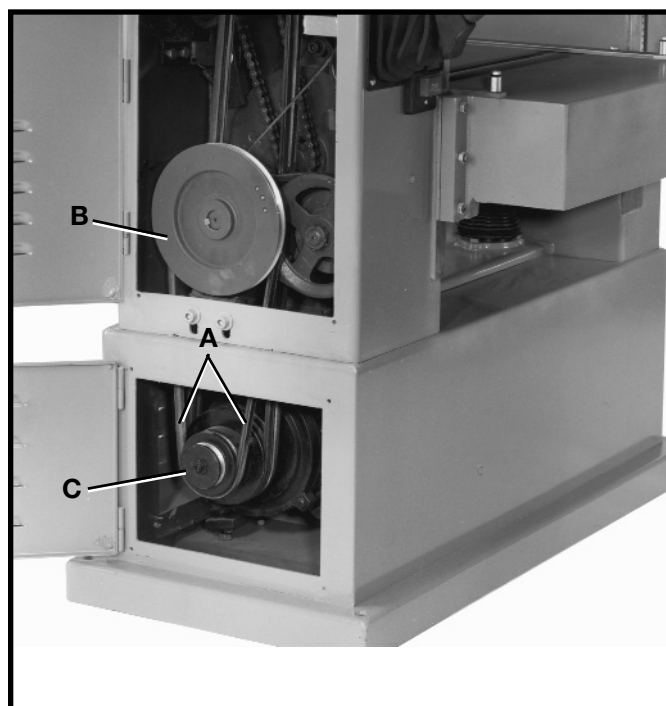

Fig. 30

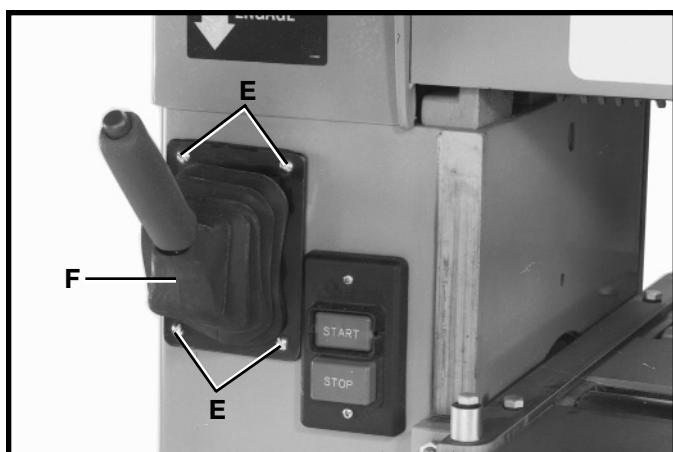

Fig. 31

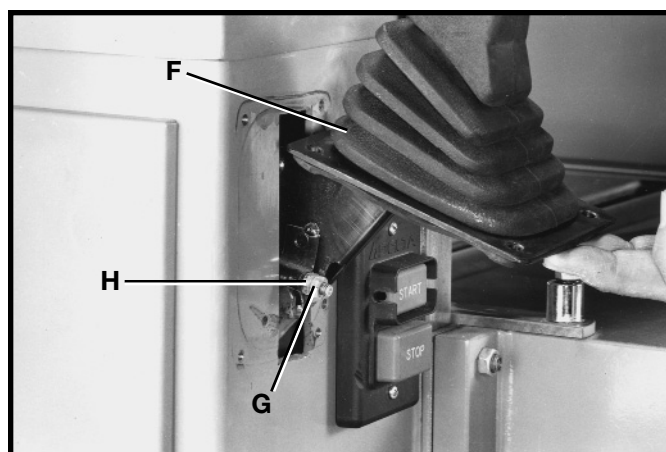

Fig. 32

CHECKING, RESETTING AND REPLACING KNIVES

When checking, resetting and replacing knives, proceed as follows:

1. **⚠ WARNING** **DISCONNECT THE MACHINE FROM THE POWER SOURCE.**
2. Remove locking screw and raise top cover (A) Fig. 33, to expose cutterhead (B).
3. Carefully place knife setting gage (C) Figs. 34 and 35, so the gage is positioned on the radiused section of cutterhead (B). When set correctly, knife (D) Figs. 34 and 35, should just contact the bottom of inset section (E) Fig. 35 of knife setting gage (C) which is set at .070 . Check the remaining knives in the same manner.
4. If an adjustment to one or all three knives is necessary, slightly loosen the 12 locking screws, one of which is shown at (F) Fig 34 and also in Fig. 35, just enough to relieve stress in cutterhead (B) and not disturb the knife setting.
5. With knife setting gage (C) Figs. 34 and 35 still in place on the cutterhead, continue to adjust the knife that must be reset by turning the 12 knife locking screws **CLOCKWISE** until knife locking bar (G) becomes loose. Lifter springs (not shown) located under the knife will automatically raise the knife until it comes in contact with the gage (C). Then snug up the knife locking bar (G) Fig. 34 and Fig. 35, by turning the ten screws (F) **COUNTERCLOCKWISE**. **IMPORTANT: AT THIS TIME, ONLY TIGHTEN THE KNIFE LOCKING BAR (G) JUST ENOUGH TO HOLD THE KNIFE (D) IN POSITION INSIDE THE CUTTERHEAD SLOT.**
6. If other knives need adjustment, repeat **STEP 5**.
7. After all the knives are positioned in the cutterhead with the knife locking screws snug, turn each of the 12 locking screws (F) Fig. 34, **COUNTERCLOCKWISE UNTIL THE KNIVES ARE SECURE IN THE CUTTERHEAD**. **NOTE:** When tightening the knife locking screws (F), tighten the end screws first, then proceed inward toward the center of the cutterhead.

⚠ DANGER **IF THE KNIVES ARE TO BE REMOVED FOR SHARPENING OR REPLACEMENT, EXTREME CARE SHOULD BE TAKEN AS THE KNIVES ARE VERY SHARP. TO REMOVE THE KNIVES, WEAR GLOVES AND PROCEED AS FOLLOWS:**

8. **⚠ WARNING** **DISCONNECT THE MACHINE FROM THE POWER SOURCE.**
9. Carefully place knife setting gage (C) Fig. 34, so it is positioned on the radiused section of the cutterhead (B) Fig. 35.
10. Loosen knife locking bar (G) Figs. 34 and 35, by turning 12 knife locking screws, 10 of which are shown at (F) **CLOCKWISE** and carefully remove locking bar (G), knife (D), and springs (not shown) which are located under the knife, from the cutterhead. Remove the remaining knives in the same manner.

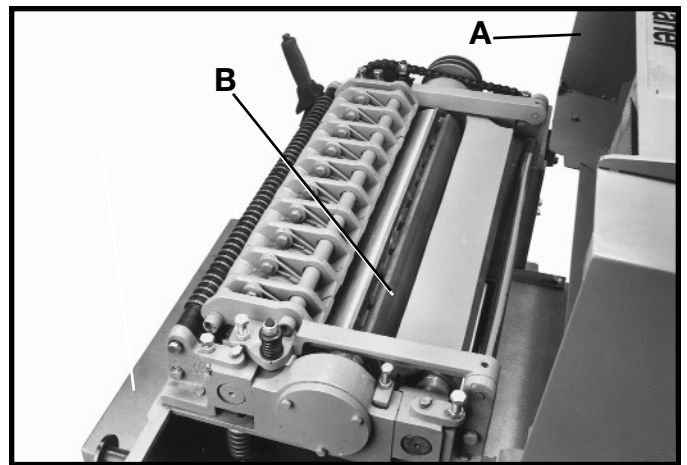

Fig. 33

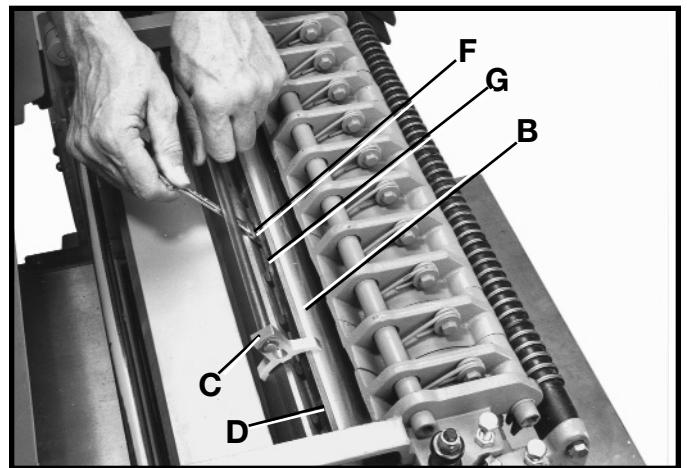

Fig. 34

11. Thoroughly clean the knife slots, knife locking bars, and locking screws. Check the screws; if the threads appear worn or stripped, or if the heads are damaged, replace them.
12. Carefully replace the springs (not shown), knives (D) Fig. 35, and knife locking bars (G) into the three slots in the cutterhead (B). **IMPORTANT: WHEN REPLACING KNIFE LOCKING BARS (G) FIG. 35, AGAINST KNIVES (D) AS SHOWN IN THE CROSS SECTIONAL ILLUSTRATION, MAKE CERTAIN KNIFE LOCKING BARS (G) ARE INSTALLED AS SHOWN, WITH LOCKING SCREWS (F) HOLDING KNIVES (D) PROPERLY INSIDE THE CUTTERHEAD SLOTS. TURN ALL KNIFE LOCKING SCREWS, ONE OF WHICH IS SHOWN AT (F), COUNTERCLOCKWISE, JUST ENOUGH TO HOLD THE KNIVES IN THE CUTTERHEAD.**
13. Adjust the knives as explained in **STEPS 3** through **7**.
14. Replace top cover on the machine.

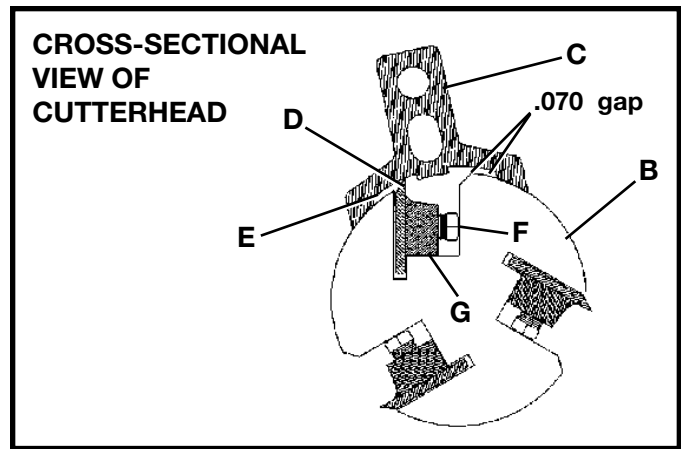

Fig. 35

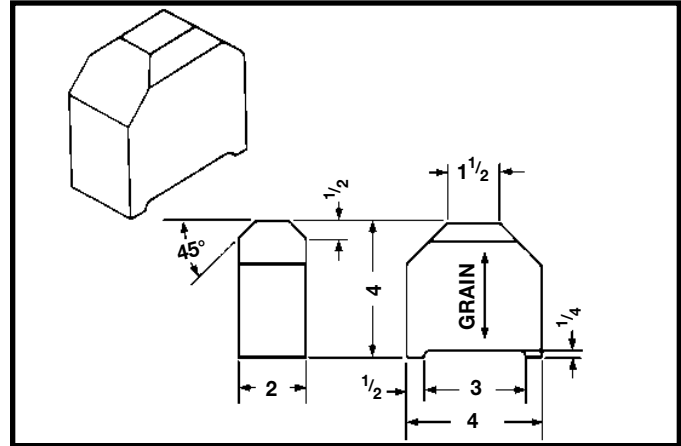

Fig. 36

CONSTRUCTING GAGE BLOCK

In order to check and adjust the height of the chipbreaker, pressure bar, infeed and outfeed rollers and adjust the cutter-head parallel to the table, you will need a gage block made of hard wood. The gage block can easily be constructed by following the dimensions shown in Fig. 36.

ADJUSTING CHIPBREAKERS

The chipbreakers (A) Fig. 37, are located on top of the planer and extend downward around the front of the cutterhead. The chipbreakers will rise as stock is fed through the planer and “break or curls” the wood chips. The bottom of the chipbreakers must be parallel to the knives and set .040 below the cutting circle. To check and adjust the chipbreakers, proceed as follows:

1. **⚠ WARNING DISCONNECT THE MACHINE FROM THE POWER SOURCE.**
2. Make certain the knives are adjusted properly as explained in section “**CHECKING, REPLACING AND RE-SETTING KNIVES.**”
3. Place gage block (B) Fig. 38, on the table surface and directly under the cutterhead as shown. Using a .040 feeler gage (C) Fig. 38, placed on top of the gage block, raise the table until cutterhead knife (D) touches the feeler gage when the knife is at its lowest point. **DO NOT MOVE THE TABLE ANY FURTHER UNTIL THE ADJUSTMENT HAS BEEN COMPLETED.**

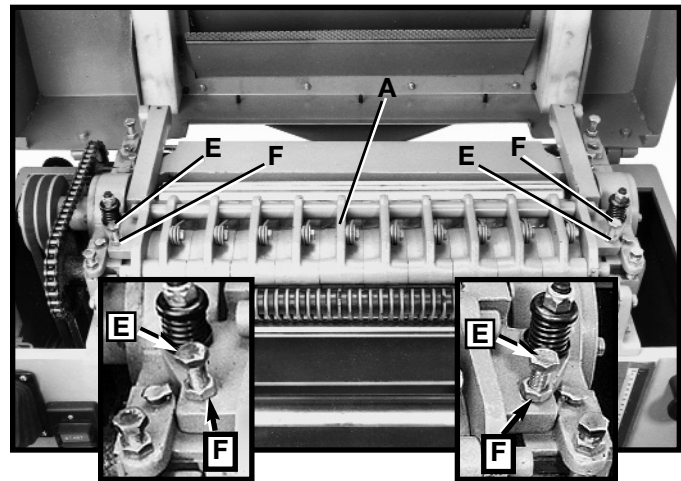

Fig. 37

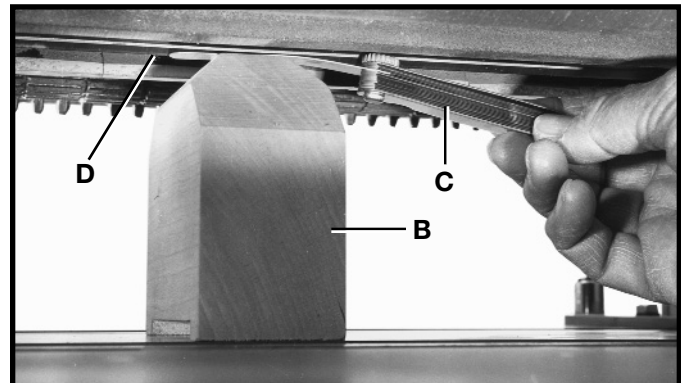

Fig. 38

4. Move gage block (B) Fig. 39, directly under chipbreakers (A) as shown. The bottom of chipbreakers (A) Fig. 39, should just touch gage block (B).
5. If an adjustment to the chipbreakers is necessary, loosen two hex nuts (E) Fig. 37, and turn adjustment screws (F) until chipbreakers (A) touch gage block (B) at both sides of the table.

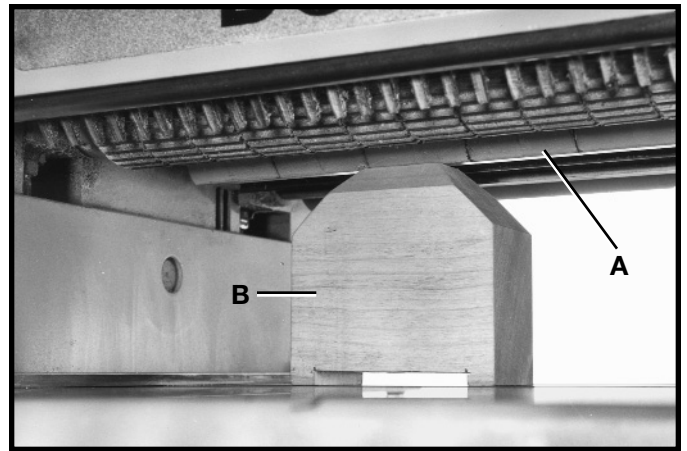

Fig. 39

ADJUSTING PRESSURE BAR

The pressure bar is located directly behind the cutterhead and rides on the planed surface of the stock, pressing the stock downward on the table. The pressure bar must be parallel to the knives and tangent to the table and set .010" below the cutting circle. To check and adjust the pressure bar, proceed as follows:

1. **⚠ WARNING DISCONNECT THE MACHINE FROM THE POWER SOURCE.**
2. Make certain the knives are adjusted properly as explained in the section "**CHECKING, ADJUSTING AND REPLACING KNIVES.**"
3. Place gage block (B) Fig. 40, on the table surface and directly under the cutterhead as shown. Using a .010" feeler gage (C) Fig. 40, placed on top of the gage block, raise the table until cutterhead knife (D) Fig. 41 touches the feeler gage when the knife is at its lowest point. **IMPORTANT: DO NOT MOVE THE TABLE ANY FURTHER UNTIL THE ADJUSTMENT HAS BEEN COMPLETED.**
4. Move gage block (B) Fig. 41, under pressure bar (D) as shown. The bottom of pressure bar (D) Fig. 41, should just touch the top of gage block (B). Check the opposite end of the pressure bar in the same manner.
5. If an adjustment to the height of the pressure bar is necessary, loosen lock nut (E) Fig. 42, and turn adjustment screw (F) until the bottom of pressure bar (D) Fig. 41, just touches top of gage block (B). Repeat the adjustment at the other end of the pressure bar in the same manner.

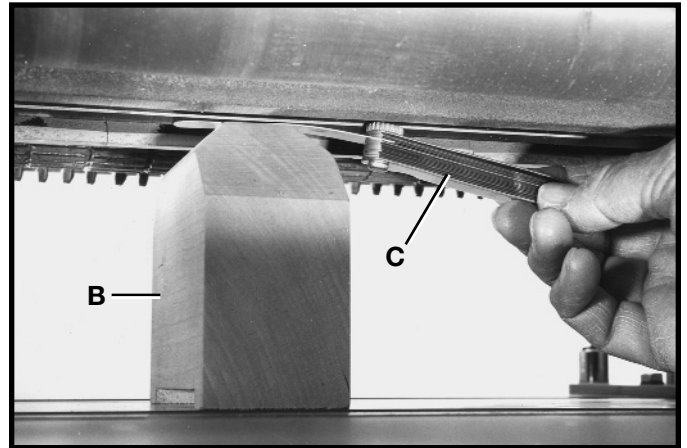

Fig. 40

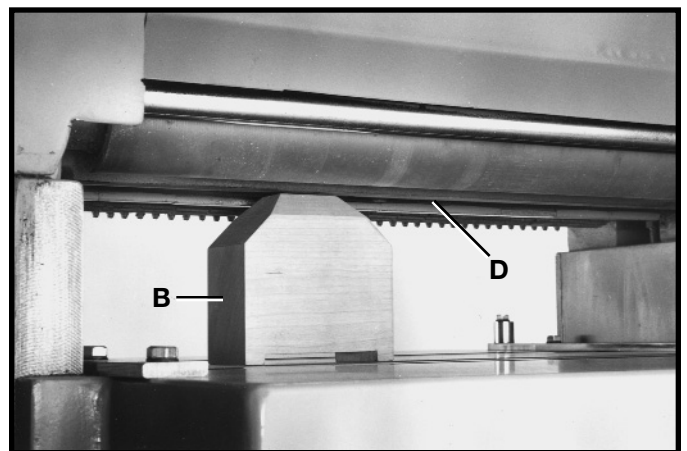

Fig. 41

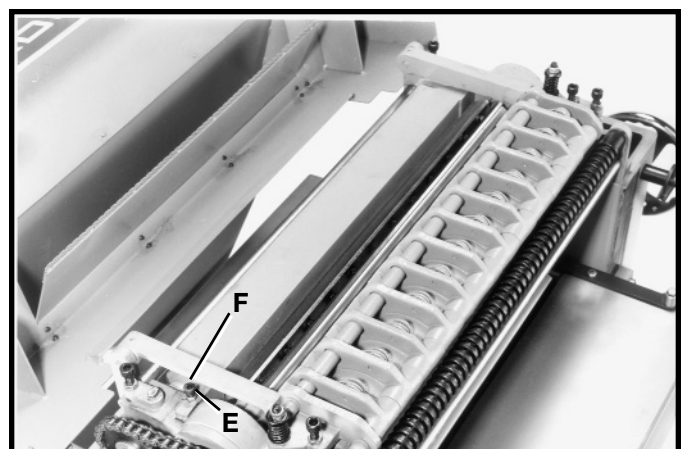

Fig. 42

ADJUSTING OUTFEED ROLLER

The outfeed roller continues to feed the stock out of the machine after the planing operation has been completed and should be set at .030" below the cutting circle.

To check and adjust the setting of the outfeed roller, proceed as follows:

1. **⚠ WARNING DISCONNECT THE MACHINE FROM THE POWER SOURCE.**
2. Make certain the knives are adjusted properly as explained in section "CHECKING, ADJUSTING AND REPLACING KNIVES."
3. Place gage block (A) Fig. 43, on the table, directly under cutterhead (B). Using a .030" feeler gage (C) placed on top of gage block (A), raise the table until the cutterhead knife just touches feeler gage (A) when the knife is at its lowest point. **NOTE:** Do not move the table any further until the adjustment is complete.
4. Place gage block (A) Fig. 44, under outfeed roller (D). The bottom of roller (D) should just touch gage block (A).
5. If an adjustment is necessary, loosen locknut (E) Fig. 45, and turn adjustment screw (F) until the outfeed roller just touches the top of gage block (A) Fig. 44.
6. Repeat the adjustment on the opposite end of the outfeed roller in the same manner.
7. Tighten locknuts (E) Fig. 45 after adjustments are completed.

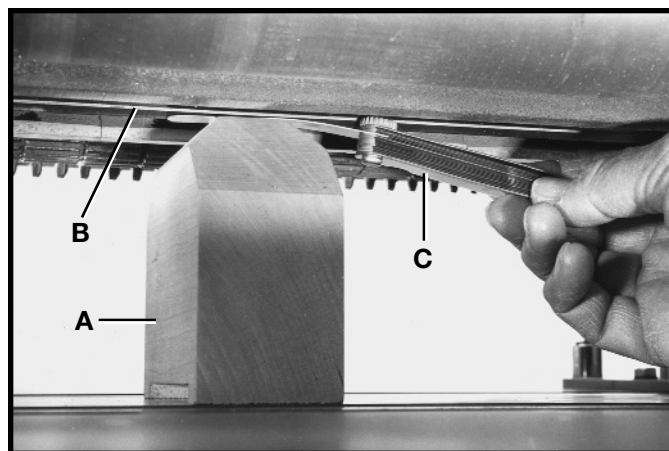

Fig. 43

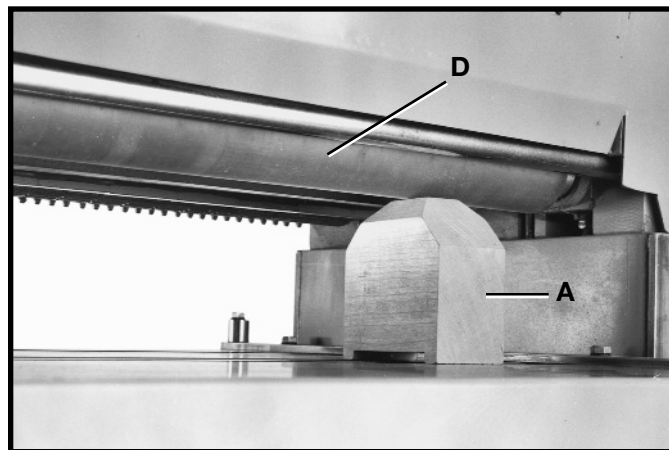

Fig. 44

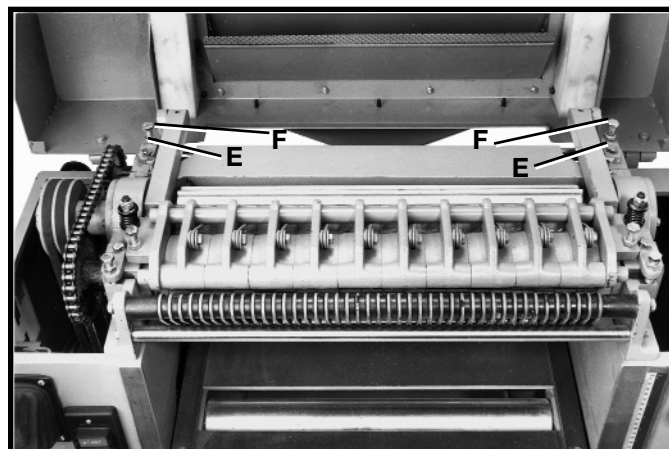

Fig. 45

ADJUSTING INFEEED ROLLER

The infeed roller feeds the stock into the planer while the stock is being surfaced. The infeed roller must be positioned uniformly across the planer and .040" below the cutting circle to feed the stock without slipping. To check the setting of the infeed roller, proceed as follows:

1. **⚠ WARNING DISCONNECT THE MACHINE FROM THE POWER SOURCE.**
2. Make certain the knives are adjusted properly as explained in section "CHECKING, ADJUSTING AND REPLACING KNIVES."
3. Place gage block (A) Fig. 46, on the table, directly under the cutterhead (B). Using a .040" feeler gage (C) placed on top of the gage block (A), raise the table until the cutterhead knife just touches feeler gage (A) when the knife is at its lowest point. **NOTE:** Do not move the table any further until the adjustment is complete.

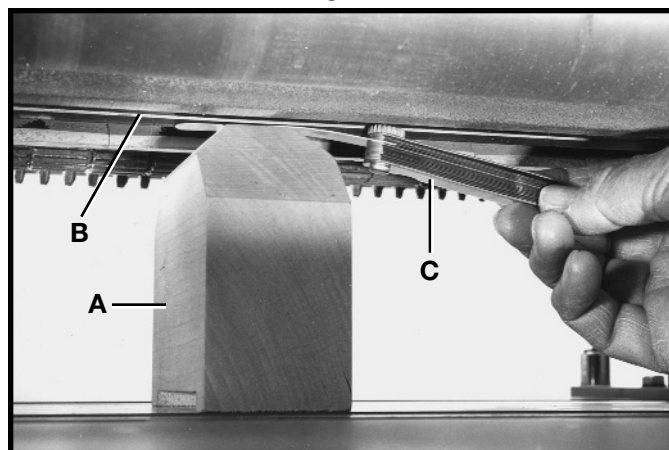

Fig. 46

4. Place gage block (A) Fig. 47, under infeed roller (D). The bottom of roller (D) should just touch gage block (A).
5. If an adjustment is necessary, loosen locknut (E) Fig. 48, and turn adjustment screw (F) until the infeed roller just touches the top of gage block (A).
6. Repeat the adjustment on the opposite end of the infeed roller in the same manner.
7. Tighten locknuts (E) Fig. 48, after adjustments are completed.

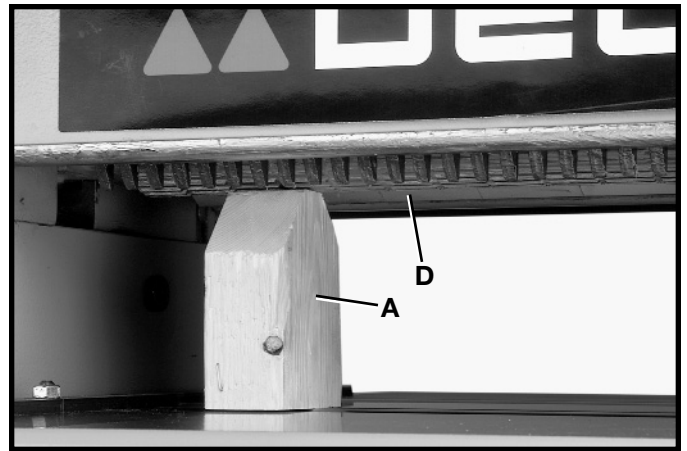

Fig. 47

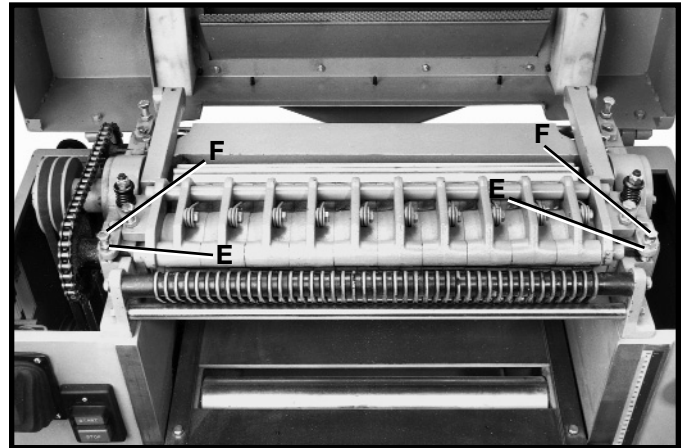

Fig. 48

LEVELING THE TABLE

The table is set parallel to the cutterhead at the factory and no further adjustment should be necessary. To check if the table is level with the cutterhead, proceed as follows:

1. **⚠ WARNING DISCONNECT THE MACHINE FROM THE POWER SOURCE.**
2. Check to see if the cutterhead knives are set correctly as explained in section “CHECKING, ADJUSTING AND REPLACING KNIVES.”
3. Then check to see if the table is set parallel to the cutterhead by placing gage block (A) Fig. 49, directly under the cutterhead on the left hand side of the table as shown. Raise the table until gage block (A) Fig. 49, just touches the cutterhead.
4. Carefully move gage block (A) Fig.50, to the right hand side of the table directly under the cutterhead. The distance from table to cutterhead should be identical.



Fig. 49



Fig. 50

- If the table is not parallel to the cutterhead, lower boot (B) Fig. 51, which is located underneath the table. **NOTE:** Table elevating handwheel must be unlocked when making this adjustment.
- Loosen lock screw (C) Fig. 51, and with large pliers (D) turn adjustment sleeve (E) as necessary until table is parallel with the cutterhead. Tighten lock screw (C) after adjustment is made and replace boot (B). **NOTE:** The same adjustment can also be made on the other side of the planer if necessary.

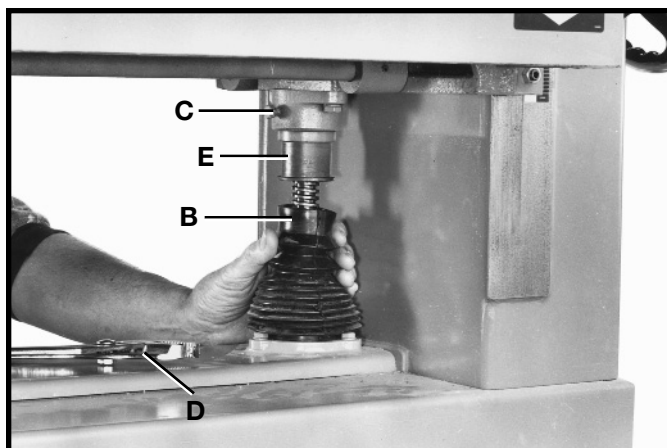

Fig. 51

ADJUSTING TABLE HEIGHT SCALE

The table height scale indicates the distance the table is from the cutting circle (depth of cut). To check and adjust the pointer, proceed as follows:

- Run a piece of wood through the planer and stop the machine.
- Measure the thickness of the planed end of the stock as shown in Fig. 52. If an adjustment is necessary, loosen screw (A) Fig. 53, adjust pointer (B) and retighten screw (A).

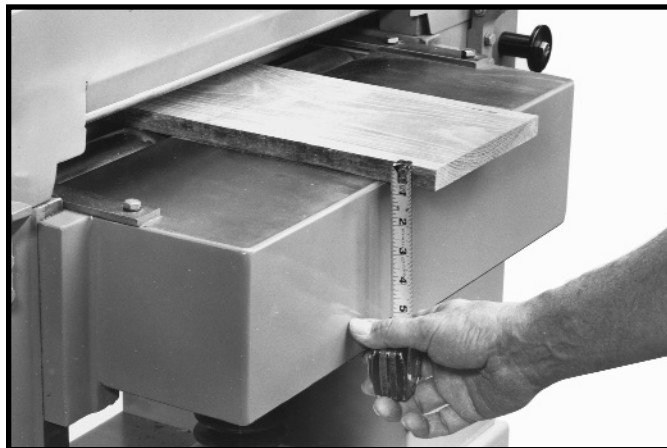

Fig. 52

ADJUSTING TABLE GIBS

In the unlikely event of the table developing unwanted movement during planing operations, the table can be checked and adjusted as follows:

- ⚠ DANGER DISCONNECT MACHINE FROM POWER SOURCE.**
- With the table in the locked position, and with a feeler gage, measure the gap between table gib (A) Fig. 54 and table bracket (B). When set correctly the gap should be .005 .
- If an adjustment is necessary, loosen three locknuts (C), and turn three adjustment screws (D) Fig. 54, as necessary to set the correct gap.
- Check and adjust the gap on the other side of the table in the same manner. Tighten six locknuts, three of which are shown at (C) Fig. 54, after adjustment is made.
- Raise and lower the table to its fullest range and check to see if the table moves up and down without binding.

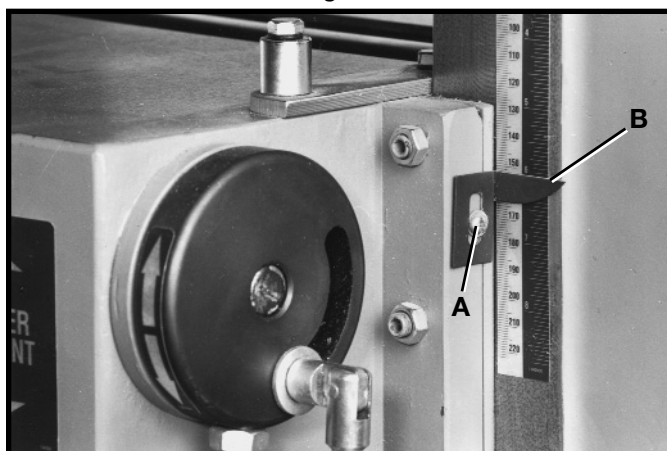

Fig. 53

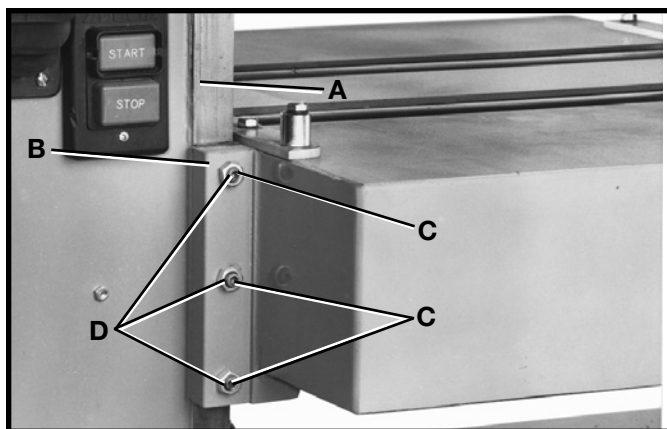

Fig. 54

MACHINE USE

When using your machine, follow these few simple steps for achieving the best results.

1. **True Up One Face** – Feed one face of the board over a jointer, making thin cuts with each pass, until the entire surface is flat.
2. **Plane to Thickness** – Place the side you planed in **STEP 1** face down and feed the board through the planer. Plane until this side is flat, then plane both sides of the board until you are satisfied with the thickness. Make thin cuts, and alternate sides with each pass. If, during the planing operation, you notice the board twisting, warping, or bowing, repeat **STEP 1** and true up one face.
3. When planing long stock, provide table extensions to support the infeed and outfeed end of the workpiece.
4. Plane with the grain only, and keep planer table clean. Occasionally, wax the table surface to reduce friction during the planing operation.
5. **Cross-cut to Final Length** – Cross-cut lumber to final length.

CAUTION

THE KNIVES ON THE PLANER WILL NOT WEAR EVENLY IF THE WOOD IS FED THROUGH THE SAME SPOT ON THE TABLE EVERY TIME. FEED THE WOOD THROUGH THE PLANER AT DIFFERENT SPOTS ON THE TABLE TO HELP ELIMINATE UNEVEN WEAR OF THE KNIVES.

TROUBLESHOOTING

For assistance with your machine, visit our website at www.deltamachinery.com for a list of service centers or call the DELTA Machinery help line at 1-800-223-7278 (In Canada call 1-800-463-3582).

MAINTENANCE

KEEP MACHINE CLEAN

Periodically blow out all air passages with dry compressed air. All plastic parts should be cleaned with a soft damp cloth. NEVER use solvents to clean plastic parts. They could possibly dissolve or otherwise damage the material.

⚠ WARNING

Wear ANSI Z87.1 safety glasses while using compressed air.

FAILURE TO START

Should your machine fail to start, check to make sure the prongs on the cord plug are making good contact in the outlet. Also, check for blown fuses or open circuit breakers in the line.

LUBRICATING WORK SURFACES

Apply household floor paste wax to the machine table and extension table or other work surface weekly.

LUBRICATING THE FEED ROLLERS

The machine's feed rollers must be lubricated about every 50 to 100 hours of use or as needed. To lubricate the machine's feed rollers, add a few drops of 10W Machine oil in the oil cups, two of which are shown at (A) and (B) in Fig. 55. The other two are in the same location on the opposite side of the rollers.

PROTECTING CAST IRON FROM RUST

To clean and protect cast iron tables from rust, you will need the following materials: 1 pushblock from a jointer, 1 sheet of medium Scotch-Brite™ Blending Hand Pad, 1 can of WD-40®, 1 can of degreaser, 1 can of TopCote® Aerosol. Apply the WD-40 and polish the table surface

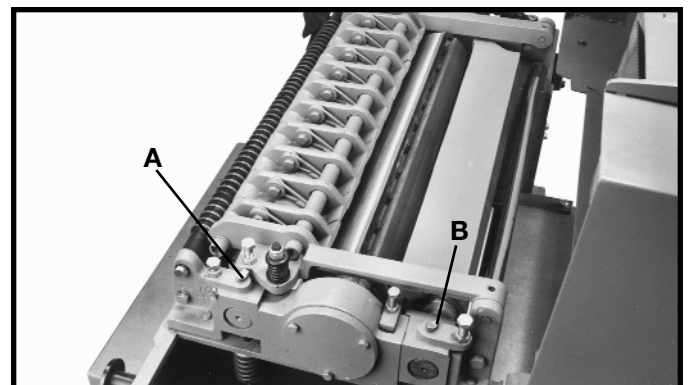

Fig. 55

with the Scotch-Brite pad using the pushblock as a hold-down. Degrease the table, then apply the TopCote® accordingly.

SERVICE



PARTS, SERVICE OR WARRANTY ASSISTANCE

All Delta Machines and accessories are manufactured to high quality standards and are serviced by a network of Porter-Cable • Delta Factory Service Centers and Delta Authorized Service Stations. To obtain additional information regarding your Delta quality product or to obtain parts, service, warranty assistance, or the location of the nearest service outlet, please call 1-800-223-7278 (In Canada call 1-800-463-3582).

ACCESSORIES

A complete line of accessories is available from your Delta Supplier, Porter-Cable • Delta Factory Service Centers, and Delta Authorized Service Stations. Please visit our Web Site www.deltamachinery.com for a catalog or for the name of your nearest supplier.

▲WARNING Since accessories other than those offered by Delta have not been tested with this product, use of such accessories could be hazardous. For safest operation, only Delta recommended accessories should be used with this product.

WARRANTY



Two Year Limited New Product Warranty

Delta will repair or replace, at its expense and at its option, any new Delta machine, machine part, or machine accessory which in normal use has proven to be defective in workmanship or material, provided that the customer returns the product prepaid to a Delta factory service center or authorized service station with proof of purchase of the product within two years and provides Delta with reasonable opportunity to verify the alleged defect by inspection. For all refurbished Delta product, the warranty period is 180 days. Delta may require that electric motors be returned prepaid to a motor manufacturer's authorized station for inspection and repair or replacement. Delta will not be responsible for any asserted defect which has resulted from normal wear, misuse, abuse or repair or alteration made or specifically authorized by anyone other than an authorized Delta service facility or representative. Under no circumstances will Delta be liable for incidental or consequential damages resulting from defective products. This warranty is Delta's sole warranty and sets forth the customer's exclusive remedy, with respect to defective products; all other warranties, express or implied, whether of merchantability, fitness for purpose, or otherwise, are expressly disclaimed by Delta.

NOTES

NOTES

PORTER-CABLE • DELTA SERVICE CENTERS (CENTROS DE SERVICIO DE PORTER-CABLE • DELTA)

Parts and Repair Service for Porter-Cable • Delta Machinery are Available at These Locations
(Obtenga Refaccion de Partes o Servicio para su Herramienta en los Siguietes Centros de Porter-Cable • Delta)

ARIZONA

Phoenix 85013-2906
4501 N. 7th Ave.
Phone: (602) 279-6414
Fax: (602) 279-5470

CALIFORNIA

Ontario 91761 (Los Angeles)
3949A East Guasti Road
Phone: (909) 390-5555
Fax: (909) 390-5554

San Diego 92111
7290 Clairemont Mesa Blvd.
Phone: (858) 279-2011
Fax: (858) 279-0362

San Leandro 94577 (Oakland)
3039 Teagarden Street
Phone: (510) 357-9762
Fax: (510) 357-7939

COLORADO

Denver 80223
700 West Mississippi Ave.
Phone: (303) 922-8325
Fax: (303) 922-0245

FLORIDA

Davie 33314 (Miami)
4343 South State Rd. 7 (441)
Unit #107
Phone: (954) 321-6635
Fax: (954) 321-6638

Tampa 33634
4909 West Waters Ave.
Phone: (813) 884-0434
Fax: (813) 888-5997

GEORGIA

Forest Park 30297 (Atlanta)
5442 Frontage Road,
Suite 112
Phone: (404) 608-0006
Fax: (404) 608-1123

ILLINOIS

Addison 60101 (Chicago)
400 South Rohlwing Rd.
Phone: (630) 424-8805
Fax: (630) 424-8895

KANSAS

Overland Park 66214
9201 Quivira Road
Phone: (913) 495-4330
Fax: (913) 495-4378

MARYLAND

Elkridge 21075 (Baltimore)
7397-102 Washington Blvd.
Phone: (410) 799-9394
Fax: (410) 799-9398

MASSACHUSETTS

Franklin 02038 (Boston)
Franklin Industrial Park
101E Constitution Blvd.
Phone: (508) 520-8802
Fax: (508) 528-8089

MICHIGAN

Madison Heights 48071 (Detroit)
30475 Stephenson Highway
Phone: (248) 597-5000
Fax: (248) 597-5004

MINNESOTA

Eden Prairie 55344
9709 Valley View Road
Phone: (952) 884-9191
Fax: (952) 884-3750

MISSOURI

St. Louis 63146
11477 Page Service Drive
Phone: (314) 997-9100
Fax: (314) 997-9183

NEW YORK

Flushing 11365-1595 (N.Y.C.)
175-25 Horace Harding Expwy.
Phone: (718) 225-2040
Fax: (718) 423-9619

NORTH CAROLINA

Charlotte 28270
9129 Monroe Road, Suite 115
Phone: (704) 841-1176
Fax: (704) 708-4625

OHIO

Columbus 43229
1948 Schrock Road
Phone: (614) 895-3112
Fax: (614) 895-3187

Parma Heights OH 44130
6485 Pearl Road
Phone: (440) 842-9100
Fax: (440) 884-3430

OREGON

Portland 97230
14811 North East Airport Way
Phone: (503) 255-6556
Fax: (503) 255-6543

PENNSYLVANIA

Willow Grove 19090
(Philadelphia)
520 North York Road
Phone: (215) 658-1430
Fax: (215) 658-1433

TEXAS

Carrollton 75006 (Dallas)
1300 Interstate 35 N, Suite 112
Phone: (972) 446-2996
Fax: (972) 446-8157

Houston 77022-2122
536 East Tidwell Rd.
Phone: (713) 692-7111
Fax: (713) 692-1107

WASHINGTON

Auburn 98001(Seattle)
3320 West Valley HWY, North
Building D, Suite 111
Phone: (253) 333-8353
Fax: (253) 333-9613

Authorized Service Stations are located in many large cities. Telephone **800-438-2486** or **731-541-6042** for assistance locating one. Parts and accessories for Porter-Cable-Delta products should be obtained by contacting any Porter-Cable-Delta Distributor, Authorized Service Center, or Porter-Cable-Delta Factory Service Center. If you do not have access to any of these, call **800-223-7278** and you will be directed to the nearest Porter-Cable-Delta Factory Service Center. Las Estaciones de Servicio Autorizadas están ubicadas en muchas grandes ciudades. Llame al **800-438-2486** ó al **731-541-6042** para obtener asistencia a fin de localizar una. Las piezas y los accesorios para los productos Porter-Cable-Delta deben obtenerse poniéndose en contacto con cualquier distribuidor Porter-Cable-Delta, Centro de Servicio Autorizado o Centro de Servicio de Fábrica Porter-Cable-Delta. Si no tiene acceso a ninguna de estas opciones, llame al **800-223-7278** y le dirigirán al Centro de Servicio de Fábrica Porter-Cable-Delta más cercano.

CANADIAN PORTER-CABLE • DELTA SERVICE CENTERS

ALBERTA

Bay 6, 2520-23rd St. N.E.
Calgary, Alberta
T2E 8L2
Phone: (403) 735-6166
Fax: (403) 735-6144

BRITISH COLUMBIA

8520 Baxter Place
Burnaby, B.C.
V5A 4T8
Phone: (604) 420-0102
Fax: (604) 420-3522

MANITOBA

1699 Dublin Avenue
Winnipeg, Manitoba
R3H 0H2
Phone: (204) 633-9259
Fax: (204) 632-1976

ONTARIO

505 Southgate Drive
Guelph, Ontario
N1H 6M7
Phone: (519) 767-4132
Fax: (519) 767-4131

QUÉBEC

1515 ave.
St-Jean Baptiste, Suite 160
Québec, Québec
G2E 5E2
Phone: (418) 877-7112
Fax: (418) 877-7123

1447, Begin
St-Laurent, (Montréal),
Québec
H4R 1V8
Phone: (514) 336-8772
Fax: (514) 336-3505

The following are trademarks of PORTER-CABLE • DELTA (Las siguientes son marcas registradas de PORTER-CABLE • DELTA S.A.) (Les marques suivantes sont des marques de fabricant de la PORTER-CABLE • DELTA): Auto-Set®, BAMMER®, B.O.S.S.®, Builder's Saw®, Contractor's Saw®, Contractor's Saw II™, Delta®, DELTACRAFT®, DELTAGRAM™, Delta Series 2000™, DURATRONIC™, Emc2™, FLEX®, Flying Chips™, FRAME SAW®, Grip Vac™, Homecraft®, INNOVATION THAT WORKS®, Jet-Lock®, JETSTREAM®, 'kickstand', LASERLOC®, MICRO-SET®, Micro-Set®, MIDI LATHE®, MORTEN™, NETWORK™, OMNIJIG®, POCKET CUTTER®, PORTA-BAND®, PORTA-PLANE®, PORTER-CABLE®&(design), PORTER-CABLE®PROFES-SIONAL POWER TOOLS, PORTER-CABLE REDEFINING PERFORMANCE™, Posi-Matic®, Q-3®&(design), QUICKSAND®&(design), QUICKSET™, QUICKSET II®, QUICKSET PLUS™, RIPTIDE™&(design), SAFE GUARD II®, SAFE-LOC®, Sanding Center®, SANDTRAP®&(design), SAW BOSS®, Sawbuck™, Sidekick®, SPEED-BLOC®, SPEEDMATIC®, SPEEDTRONIC®, STAIR EASE®, The American Woodshop®&(design), The Lumber Company®&(design), THE PROFESSIONAL EDGE®, THE PROFESSIONAL SELECT®, THIN-LINE™, TIGER®, TIGER CUB®, TIGER SAW®, TORQ-BUSTER®, TORQ-BUSTER®, TRU-MATCH™, TWIN-LITE®, UNIGUARD®, Unifence®, UNIFEEDER™, Unihead®, Uniplane™, Unirip®, Unisaw®, Univise®, Versa-Feeder®, VERSA-PLANE®, WHISPER SERIES®, WOODWORKER'S CHOICE™.

Trademarks noted with ™ and ® are registered in the United States Patent and Trademark Office and may also be registered in other countries. Las Marcas Registradas con el signo de ™ y ® son registradas por la Oficina de Registros y Patentes de los Estados Unidos y también pueden estar registradas en otros países.