

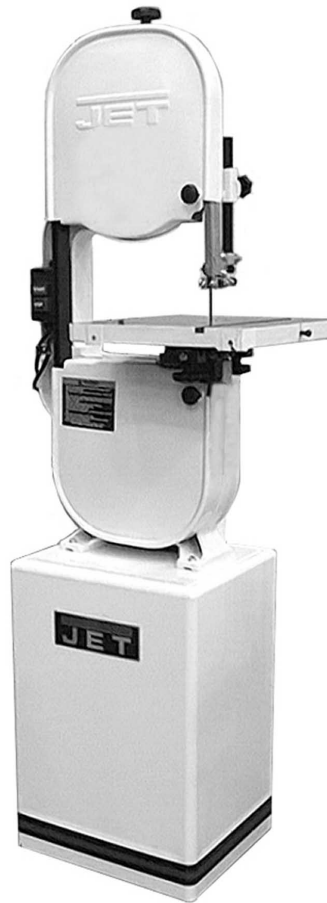

Operating Instructions and Parts Manual

14-inch Deluxe Band Saw

Models: JWBS-14DX



WMH TOOL GROUP

2420 Vantage Drive
Elgin, Illinois 60123
Ph.: 800-274-6848
www.wmhtoolgroup.com

Part No. M-710115
Revision E 9/05
Copyright © WMH Tool Group

This manual has been prepared for the owner and operators of a JET Model JWBS-14DX Band Saw. Its purpose, aside from proper machine operation, is to promote safety through the use of accepted operating and maintenance procedures. To obtain maximum life and efficiency from your band saw, and to aid in using the machine safely, read this manual thoroughly and follow all instructions carefully.

Warranty and Service

WMH Tool Group warrants every product it sells. If one of our tools needs service or repair, one of our Authorized Service Center located throughout the United States can provide quick service or information.

In most cases, a WMH Tool Group Service Center can assist in authorizing repair work, obtaining parts, or perform routine or major maintenance repair on your JET product.

For the name of an Authorized Service Center in your area, please call 1-800-274-6848, or visit our web site at www.wmhtoolgroup.com

More Information

Remember, WMH Tool Group is consistently adding new products to the line. For complete, up-to-date product information, check with your local WMH Tool Group distributor, or visit our web site at www.wmhtoolgroup.com

WMH Tool Group Warranty

WMH Tool Group makes every effort to assure that its products meet high quality and durability standards and warrants to the original retail consumer/purchaser of our products that each product be free from defects in materials and workmanship as follows: 1 YEAR LIMITED WARRANTY ON ALL PRODUCTS UNLESS SPECIFIED OTHERWISE. This Warranty does not apply to defects due directly or indirectly to misuse, abuse, negligence or accidents, normal wear-and-tear, repair or alterations outside our facilities, or to a lack of maintenance.

WMH TOOL GROUP LIMITS ALL IMPLIED WARRANTIES TO THE PERIOD SPECIFIED ABOVE, BEGINNING FROM THE DATE THE PRODUCT WAS PURCHASED AT RETAIL. EXCEPT AS STATED HEREIN, ANY IMPLIED WARRANTIES OR MERCHANTABILITY AND FITNESS ARE EXCLUDED. SOME STATES DO NOT ALLOW LIMITATIONS ON HOW LONG THE IMPLIED WARRANTY LASTS, SO THE ABOVE LIMITATION MAY NOT APPLY TO YOU. IN NO EVENT SHALL WMH TOOL GROUP BE LIABLE FOR DEATH, INJURIES TO PERSONS OR PROPERTY, OR FOR INCIDENTAL, CONTINGENT, SPECIAL, OR CONSEQUENTIAL DAMAGES ARISING FROM THE USE OF OUR PRODUCTS. SOME STATES DO NOT ALLOW THE EXCLUSION OR LIMITATION OF INCIDENTAL OR CONSEQUENTIAL DAMAGES, SO THE ABOVE LIMITATION OR EXCLUSION MAY NOT APPLY TO YOU.

To take advantage of this warranty, the product or part must be returned for examination, postage prepaid, to an Authorized Service Center designated by our office. Proof of purchase date and an explanation of the complaint must accompany the merchandise. If our inspection discloses a defect, we will either repair or replace the product at our discretion, or refund the purchase price if we cannot readily and quickly provide a repair or replacement. We will return the repaired product or replacement at WMH Tool Group's expense, but if it is determined there is no defect, or that the defect resulted from causes not within the scope of WMH Tool Group's warranty, then the user must bear the cost of storing and returning the product. This warranty gives you specific legal rights; you may also have other rights, which vary from state to state.

WMH Tool Group sells through distributors only. Members of the WMH Tool Group reserve the right to effect at any time, without prior notice, alterations to parts, fittings and accessory equipment, which they may deem necessary for any reason whatsoever.

Table of Contents

Warranty	2
Safety Warnings	4-5
Safety Decal	6
Grounding Instructions	7
115 Volt Operation	7
230 Volt Operation	8
Specifications	9
Fasteners	10
Receiving	11
Assembly	11
Tilting the Table	14
Adjusting 90° Stop	14
Changing Blades	15
Adjusting Blade Tension	15
Adjusting Blade Tracking	16
Adjusting Upper Blade Guide Assembly	16
Adjusting Upper Blade Guides & Blade Support Bearing	17
Adjusting Lower Blade Guides & Blade Support Bearing	18
Trouble-shooting	19
Parts Breakdowns:	
Body Assembly	20-23
Closed Stand Assembly	24-25
Optional Accessories	26
Electrical Schematic – 115V	27
Electrical Schematic – 230V	28

 **WARNING**

As with all machines, there is a certain amount of hazard involved with the use of this band saw. Use the machine with the respect and caution demanded where safety precautions are concerned. When normal safety precautions are overlooked or ignored, personal injury to the operator can result.

- **READ, UNDERSTAND AND FOLLOW** the safety and operating instructions found in this manual. Know the limitations and hazards associated with this machine.
- **KEEP GUARDS IN PLACE** and in working order.
- **REMOVE ADJUSTING KEYS AND WRENCHES.** Form the habit of checking to see that keys and adjusting wrenches are removed from the tool before turning it on.
- **KEEP THE WORK AREA CLEAN.** Cluttered areas and benches invite accidents.
- **DO NOT USE IN A DANGEROUS ENVIRONMENT.** Don't use power tools in damp or wet locations, or expose them to rain. Keep work area well lighted.
- **KEEP CHILDREN AWAY.** All visitors should be kept a safe distance from the work area.
- **MAKE THE WORKSHOP CHILD PROOF** with padlocks, master switches, or by removing starter keys.
- **DON'T FORCE THE TOOL.** It will do the job better and safer at the rate for which it was designed.
- **USE THE RIGHT TOOL.** Don't force a tool or attachment to do a job for which it was not designed.
- **USE THE PROPER EXTENSION CORD.** Make sure your extension cord is in good condition. When using an extension cord, be sure to use one heavy enough to carry the current your product will draw. An undersize cord will cause a drop in line voltage resulting in loss of power and overheating. The table below shows the correct size to use depending on cord length and nameplate ampere rating. If in doubt, use the next heavier gauge. The smaller the gauge number, the heavier the cord.

Cord Length		Cord Gauge
<u>115 volt</u>	<u>230 volt</u>	
25'	50'	16 AWG
50'	100'	16 AWG
100'	200'	14 AWG
150'	300'	12 AWG

- **WEAR PROPER APPAREL.** Do not wear loose clothing, gloves, neckties, rings, bracelets, or other jewelry which may get caught in moving parts. Nonslip footwear is recommended. Wear protective hair covering to contain long hair.
- **ALWAYS USE SAFETY GLASSES.** Also use face or dust masks if the cutting operation is dusty. NOTE: Common eyeglasses only have impact resistant lenses, they are NOT safety glasses.

- **SECURE WORK.** Use clamps or a vise to hold the work when it's practical. It's safer than using your hand and it frees both hands to operate the tool.
- **DON'T OVERREACH.** Keep proper footing and balance at all times.
- **MAINTAIN TOOLS WITH CARE.** Keep tools sharp and clean for best and safest performance. Follow instructions for lubricating and changing accessories.
- **DISCONNECT TOOLS** before servicing; when changing accessories, such as blades, bits cutters, and the like.
- **REDUCE THE RISK OF UNINTENTIONAL STARTING.** Make sure the switch is in the off position before plugging in the machine.
- **USE RECOMMENDED ACCESSORIES.** Consult the owner's manual for recommended accessories. The use of improper accessories may cause a risk of injury.
- **NEVER STAND ON A TOOL.** Serious injury could occur if the tool is tipped or if the cutting tool is unintentionally contacted.
- **CHECK DAMAGED PARTS.** Before further use of the tool, a guard or other part that is damaged should be carefully checked to determine that it will operate properly and perform its intended function. Check for alignment of moving parts, binding of moving parts, breakage of parts, mounting, and any other conditions that may affect its operation. A guard or other part that is damaged should be properly repaired or replaced.
- **DIRECTION OF FEED.** Feed work into a blade or cutter against the direction of rotation of the blade or cutter only.
- **NEVER LEAVE THE TOOL RUNNING UNATTENDED. TURN THE POWER OFF.** Don't leave the tool until it comes to a complete stop.
- **DRUGS, ALCOHOL, MEDICATION.** Do not operate this machine while under the influence of drugs, alcohol, or medication.
- **HEALTH HAZARDS.** Some dust created by power sanding, sawing, grinding, drilling and other construction activities contains chemicals known to cause cancer, birth defects or other reproductive harm. Some examples of these chemicals are:
 - * Lead from lead-based paint.
 - * Crystalline silica from bricks and cement and other masonry products.
 - * Arsenic and chromium from chemically-treated lumber.
 Your risk from these exposures varies, depending on how often you do this type of work. To reduce your exposure to these chemicals, work in a well-ventilated area, and work with approved safety equipment, such as those dust masks that are specifically designed to filter out microscopic particles.

SAFETY DECAL

Familiarize yourself with the location and content of this decal on your machine.

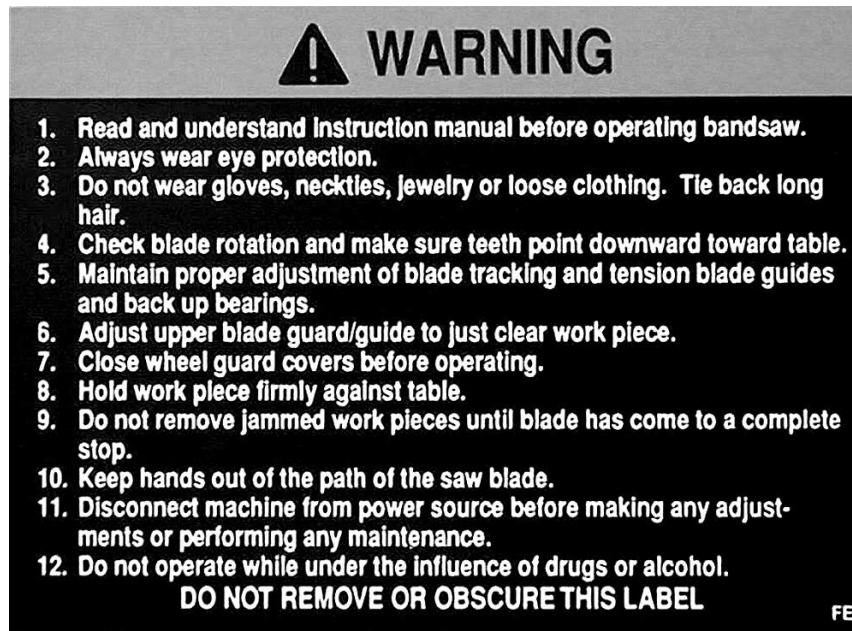

Fig. 1

Grounding Instructions

Caution: This tool must be grounded while in use to protect the operator from electric shock.

In the event of a malfunction or breakdown, grounding provides a path of least resistance for electric current to reduce the risk of electric shock. This tool is equipped with an electric cord having an equipment-grounding conductor and a grounding plug. The plug must be plugged into a matching outlet that is properly installed and grounded in accordance with all local codes and ordinances.

Do not modify the plug provided. If it will not fit the outlet, have the proper outlet installed by a qualified electrician.

Improper connection of the equipment-grounding conductor can result in a risk of electric shock. The conductor, with insulation having an outer surface that is green with or without yellow stripes, is the equipment-grounding conductor. If repair or replacement of the electric cord or plug is necessary, do not connect the equipment-grounding conductor to a live terminal.

Check with a qualified electrician or service personnel if the grounding instructions are not completely understood, or if in doubt as to whether the tool is properly grounded. Use only three wire extension cords that have three-prong grounding plugs and three-pole receptacles that accept the tool's plug.

Repair or replace a damaged or worn cord immediately.

115 Volt Operation

As received from the factory, your bandsaw is ready to run at 115 volt operation. This bandsaw, when wired for 115 volts, is intended for use on a circuit that has an outlet and a plug that looks like the one illustrated in Fig. 2. A temporary adapter, like the adapter in Fig. 3, may be used to connect this plug to a two-prong receptacle, as shown in Fig. 3, if a properly grounded outlet is not available. The temporary adapter should only be used until a properly grounded outlet can be installed by a qualified electrician. **This adapter is not applicable in Canada.** The green colored rigid ear, lug, or tab, extending from the adapter, must be connected to a permanent ground such as a properly grounded outlet box, as shown in Fig. 3.

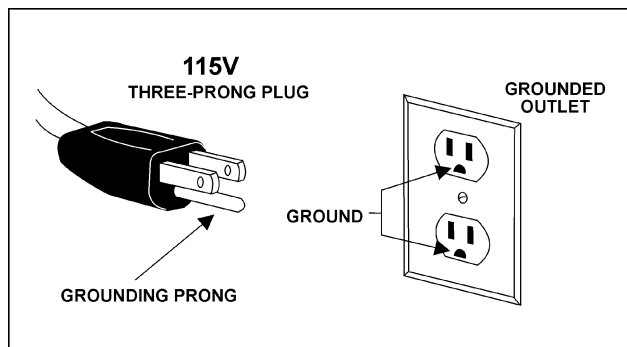

Fig. 2

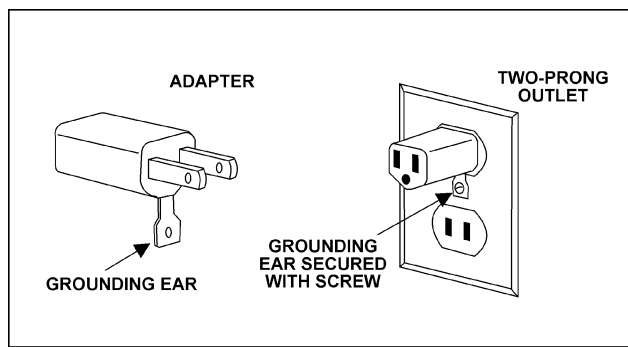

Fig. 3

230 Volt Operation

If 230V, single-phase operation is desired, the following instructions must be followed:

1. **Disconnect the machine from the power source.**
2. This band saw is supplied with four motor leads that are connected for 115V operation, as shown in Fig. 4. Reconnect these four motor leads for 230V operation, as shown in Fig. 5.
3. The 115V attachment plug supplied with the band saw must be replaced with a UL/CSA listed plug suitable for 230V operation (Fig. 6). Contact your local authorized WMH Tool Group service center or qualified electrician for proper procedures to install the plug. The band saw must comply with all local and national codes after the 230 volt plug is installed.
4. The band saw with a 230 volt plug should only be connected to an outlet having the same configuration (Fig. 6). No adapter is available or should be used with the 230 volt plug.

Important: In all cases (115 or 230 volts), make certain the receptacle in question is properly grounded. If you are not sure, have a registered electrician check the receptacle.

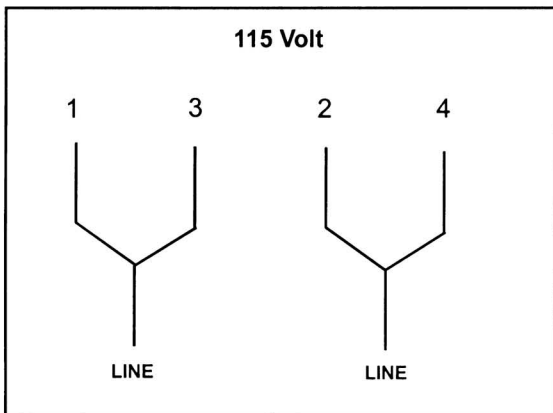

Fig. 4

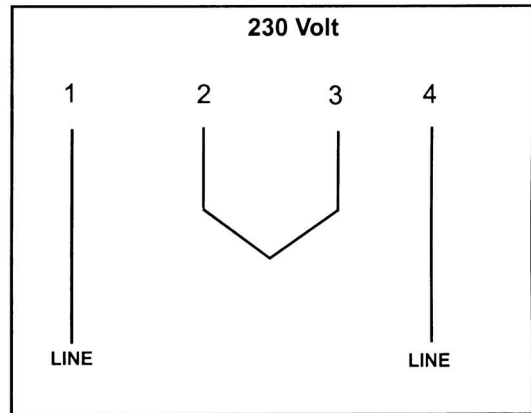

Fig. 5

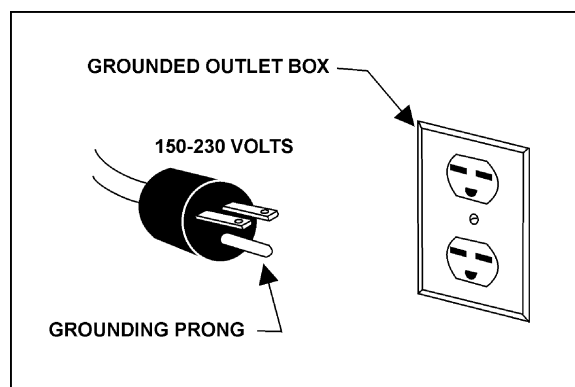

Fig. 6

Specifications:

JWBS-14DX Band Saw

Stock Number	710115K
Cutting Capacity (height).....	6"
Cutting Capacity (width)	13-1/2"
Minimum Blade Width.....	1/8"
Maximum Blade Width.....	3/4"
Blade Length.....	93-1/2"
Blade Speed	3000 SFPM
Table Size.....	15" x 15"
Table Slot Size.....	3/8"D x 3/4"W
Table Height from Floor	43-1/2"
Table Tilt (L-R).....	45°R / 10°
Dust Chute Diameter.....	4" O.D.
Overall Dimensions.....	68"H x 26"W x 19"D
Motor	1.25 HP, 1Ph, 115/230V (prewired 115V)
Net Weight (approx.).....	185 lb.
Shipping Weight (approx.).....	197 lb.

The specifications in this manual are given as general information and are not binding. WMH Tool Group reserves the right to effect, at any time and without prior notice, alterations to parts, fittings, and accessory equipment deemed necessary for any reason whatsoever.

Fasteners for JWBS-14DX

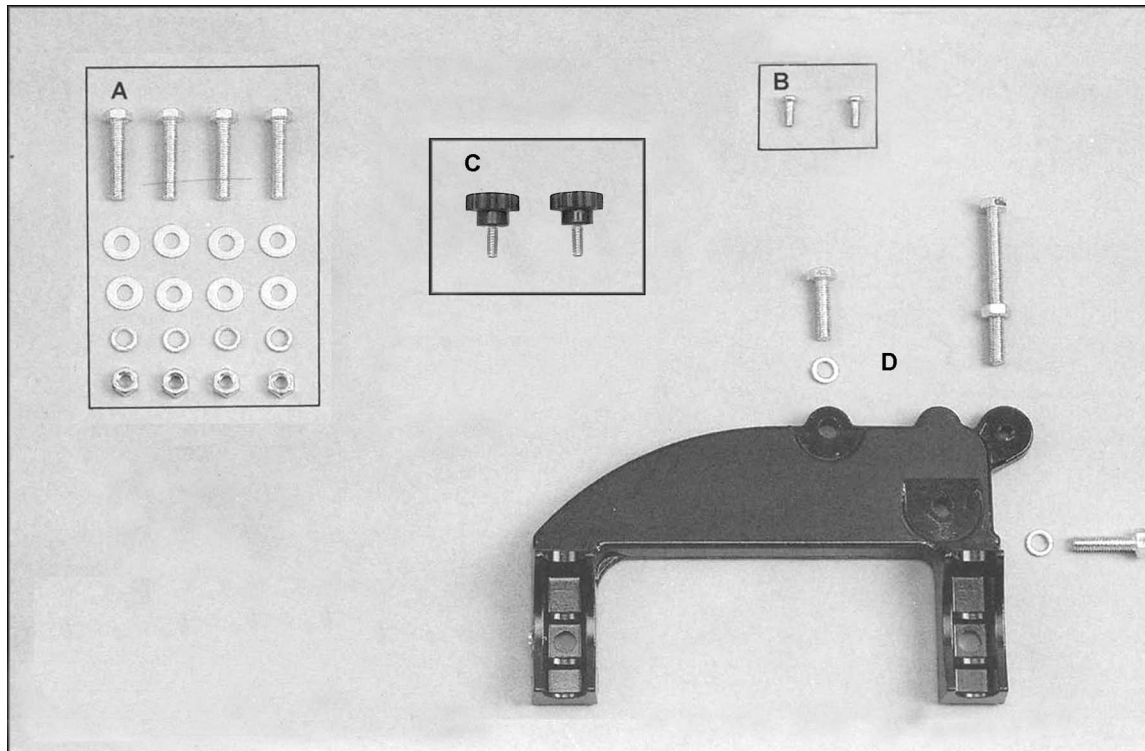

Fig. 7

A. Saw Body to Stand

- 4 – M8x40 hex cap screws
(approx. 1-1/2" long)
- 8 – M8 flat washers
- 4 – M8 lock washers
- 4 – M8 hex nuts

B. Strain Relief Plate to Stand

- 2 – M5x12 pan head machine screws

C. Belt Cover to Base

- 2 – Knobs

D. Trunnion Bracket to Saw Body

- 2 – M8x30 hex cap screws
(approx. 1-1/4" long)
- 2 – M8 lock washers
- 1 – M8x80 hex cap screw (for table stop -
(approx. 3-1/8" long)
- 1 – M8 hex nut

Receiving

Open both shipping containers and check for shipping damage. Report any damage immediately to your distributor and shipping agent. Read the instruction manual thoroughly for assembly, maintenance and safety instructions.

Contents of Shipping Containers

Container One

- 1 Stand with motor

Container Two

- 1 Saw body
- 1 V-belt
- 1 Belt cover
- 1 Trunnion support bracket
- 1 Table
- 2 Table lock knobs
- 1 Table pin
- 1 Table insert
- 1 Fastener package (see fastener page)
- 1 Instruction manual
- 1 Warranty card

Tools Required for Assembly

3/8" to 1" combination wrench set and adjustable wrench
#1 and #2 cross point screwdrivers

Assembly

Exposed metal surfaces, such as the table, have been given a protective coating. This should be cleaned with a soft cloth and solvent, such as kerosene. Do not use an abrasive pad, and do not get solvents on plastic parts.

1. Remove belt cover from inside of stand.
2. Place cabinet stand upright on a level surface. If desired, the stand can be further stabilized by securing it to the floor with lag screws through the inside corner holes. If using a mobile base, lock the casters before assembling or operating the band saw.
3. With the aid of a second person, lift the saw body out of the shipping container and place onto stand top. Be sure front of saw (with JET logo) faces stand front (JET logo).

⚠ WARNING

Saw body is heavy! Use caution when lifting and stabilize until firmly attached to the stand! Failure to comply may cause serious injury!

4. Line up holes in saw body with holes in the top of the stand. Fasten saw body to the stand with four M8 x 40 hex cap screws, eight M8 washers, four M8 lock washers, and four M8 hex nuts (as shown in item A, page 10).
5. Push motor cord and strain relief plate through the opening in the side of the stand (Fig. 8). Fasten the strain relief plate to the stand with two M5 x 12 pan head machine screws (shown in item B, page 10).
6. Check the alignment of the pulleys by placing a straight edge against the flat sides of the motor and wheel pulleys (Fig. 8a). If the pulleys lie in a straight plane (Fig. 8b) they are aligned. If they do not lie in a straight plane, loosen the set screw on one of the pulleys and shift the pulley in or out until both pulleys lie in a straight plane. Tighten set screw.
7. Open the lower door, and place the v-belt around the motor pulley and the wheel pulley (see Fig. 8a).
8. Loosen the nuts on the four motor mounting bolts (Fig. 8c) and tension the v-belt by pushing down on the motor. Tighten the four motor mounting nuts.

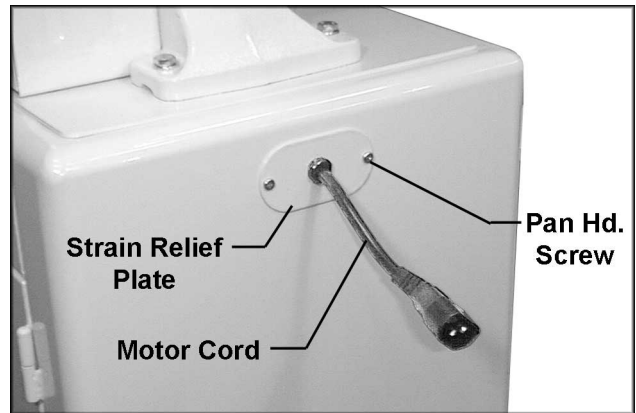

Fig. 8

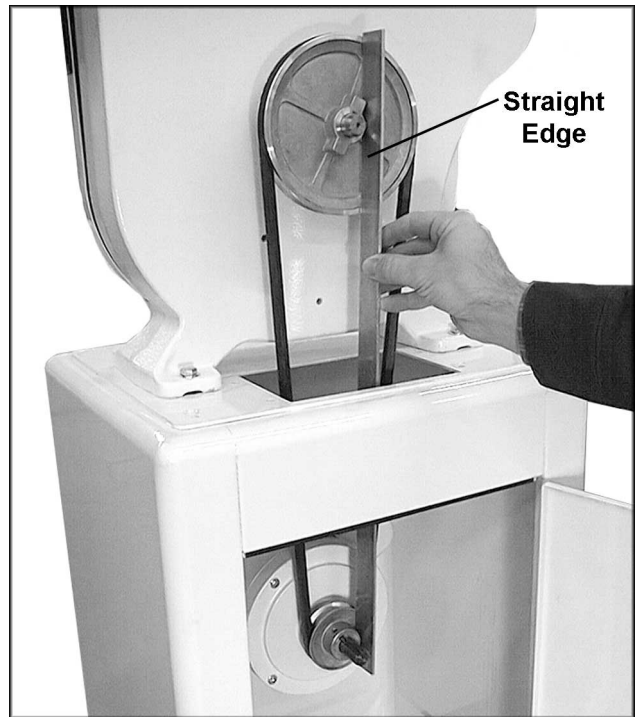

Fig. 8a

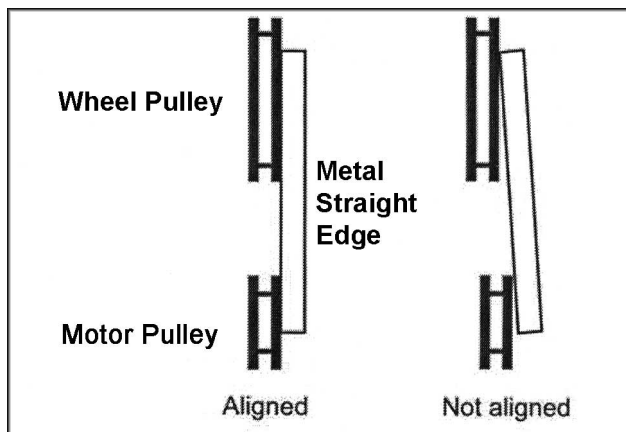

Fig. 8b



Fig. 8c

9. The v-belt is properly tensioned when finger pressure between the two pulleys causes approximately 1/2" deflection (fig. 8d).

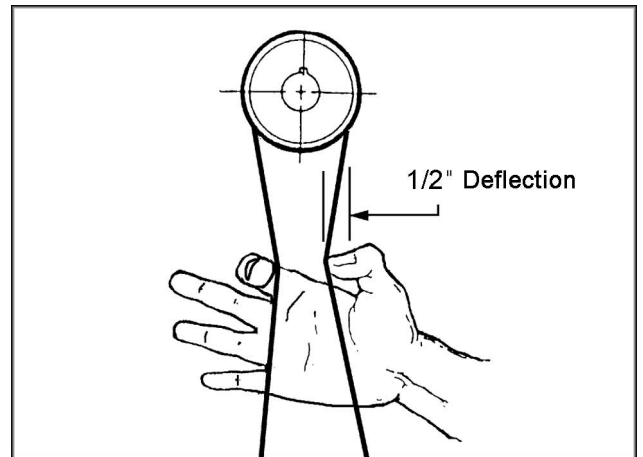

Fig. 8d

10. Screw the two small knobs (Fig. 9) into the threaded holes in the saw body. Slide the pulley cover down over the knobs, and tighten the knobs.

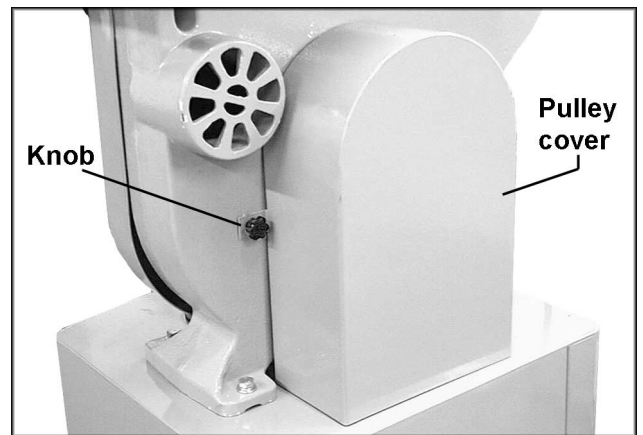

Fig. 9

11. Attach trunnion support to saw body with two M8 x 30 hex cap screws and two M8 lock washers (as in item D, page two). See Figure 12.

12. Thread nut on to table stop bolt (Fig. 12) and attach to trunnion support bracket as shown.

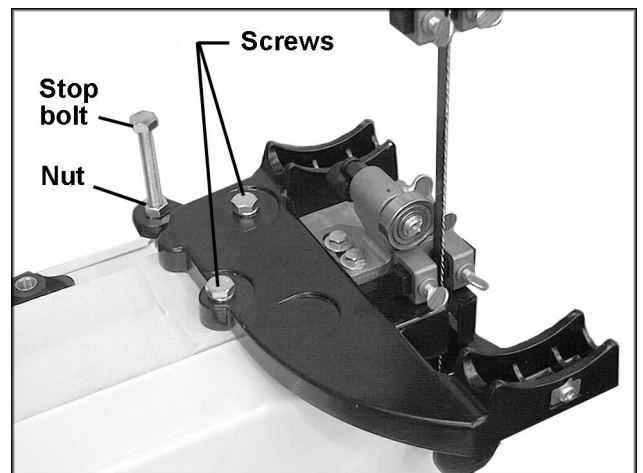

Fig. 12

13. To mount the table, remove pin and insert from the table (Fig. 13).
14. Rotate the table so that the saw blade will slide through the slot in the table. Then orient the table so the screws will slide into the holes on the trunnion support bracket. Attach lock knobs to these screws (Fig. 13).
15. Replace pin and insert.

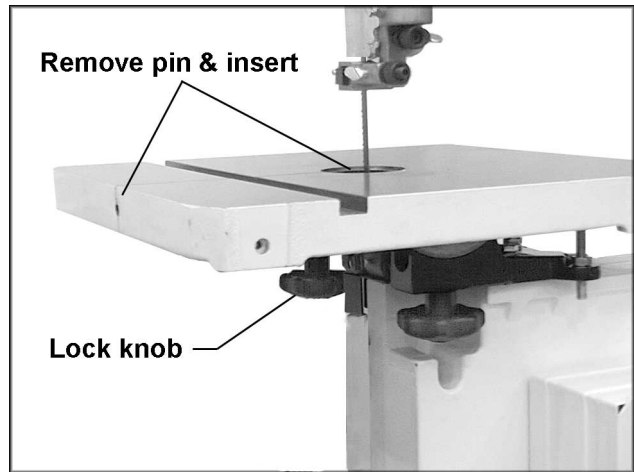

Fig. 13

16. Connect the plugs of the motor cord and switch cord (Fig. 13a).
17. Transportation and handling may have caused some fasteners to loosen. Before operating, check all screws, bolts, and nuts to make sure they are snug. Operate machine only after reading the entire manual including blade tracking, blade guide adjustments, and safety rules.

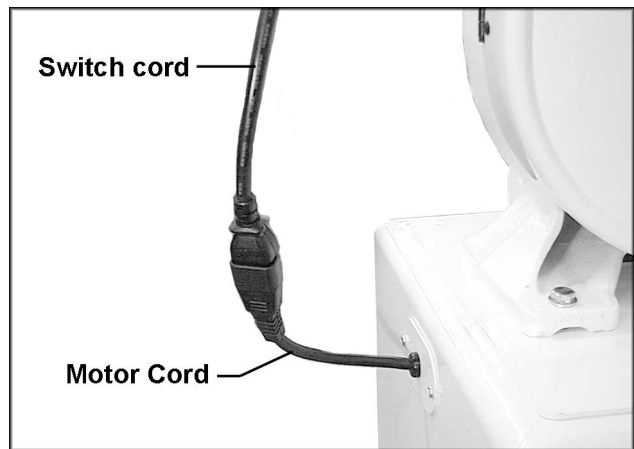

Fig. 13a

Tilting the Table

⚠ WARNING
Unplug the machine from the power source before making any repair or adjustment!
Failure to comply may cause serious injury!

1. Loosen two lock knobs (Fig. 14).
2. Tilt table up to 45 degrees to the right or up to 10 degrees to the left, using the scale mounted to the trunnion.
3. Tighten two lock knobs (Fig.14).

Note: Table stop must be removed to tilt table to the left.

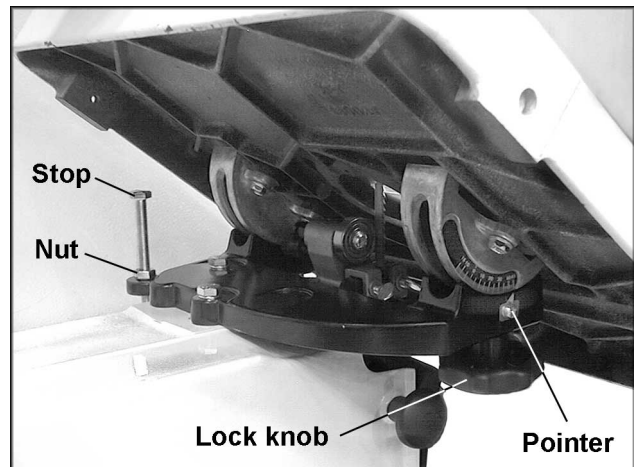

Fig. 14

Adjusting 90° Table Stop

1. **Disconnect machine from the power source.**
2. Loosen lock knobs (Fig. 14) and tilt table left until it rests against table stop.
3. Use a square placed on the table and against the blade (Fig. 15) to see if the table is 90 degrees to the blade.
4. If an adjustment is necessary, loosen lock knobs, tilt table to the right, and lock in place.
5. Loosen jam nut and turn table stop (Fig. 14) left or right to raise or lower the stop. Tighten jam nut to hold table stop in place.
6. Unlock table, tilt back onto table rest and confirm table is 90 degrees with the blade.
7. If necessary, adjust scale pointer to zero.

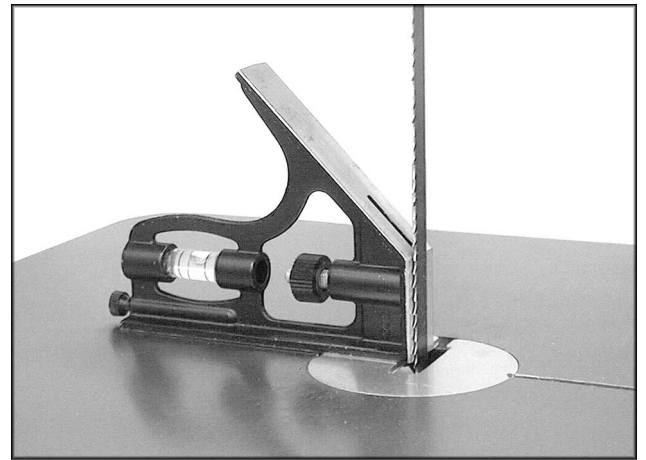

Fig. 15

Changing Blades

WARNING
Blade teeth are sharp! Use care when handling the saw blade.
Failure to comply may cause serious injury!

1. **Disconnect machine from power source.**
2. Loosen blade tension by pushing up on the release lever (Fig. 16).
3. Remove the table insert and the table pin.
4. Open both wheel covers.
5. Remove the blade from between upper and lower blade guides. Remove blade from upper and lower wheels. Turn blade to direct through slot in table.
6. Guide new blade through table slot. Place blade in upper and lower blade guides. **Note:** Make sure blade teeth point down toward table.
7. Place blade in the middle of the upper and lower wheel.
8. Replace table insert and table pin.

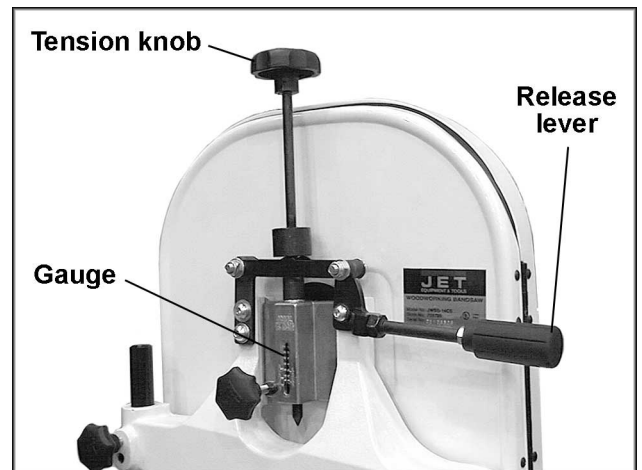

Fig. 16

9. Tension and track blade before operating saw. Find instructions for tensioning and tracking the blade under "Adjusting Blade Tension" and "Adjusting Blade Tracking".

Adjusting Blade Tension

1. **Disconnect machine from power source.**
2. Turn blade tension knob (Fig. 16) clockwise to tension blade. A gauge on the upper wheel slide bracket indicates the approximate tension according to the width of the blade. Initially, set the blade tension to correspond to blade width.
3. As you become familiar with the saw, you may find it necessary to change the blade tension from the initial setting. Changes in blade width and the type of material being cut will have an effect on blade tension.
4. Keep in mind that too little or too much blade tension can cause blade breakage.

Adjusting Blade Tracking



WARNING

**Disconnect machine from the power source!
Never adjust blade tracking with the
machine running!
Failure to comply may cause serious injury!**

"Tracking" refers to how the blade is situated upon the wheels while in motion. The blade should track in the center of both wheels.

1. The blade must be properly tensioned before adjusting blade tracking. The release lever should be in the down (tensioned) position. Make sure blade guides and blade bearings do not interfere with the blade.
2. Open top blade cover. Rotate the wheel forward and observe the position of the blade on the wheel - it should be in the center of the wheel. See Fig. 17a.
3. If adjustment is necessary, loosen wing nut (Fig. 17), and tighten tracking knob slightly to move blade toward rear of machine. Slightly loosening the tracking knob will cause the blade to track toward the front of the machine.
4. Tighten wing nut after blade is tracking in the center of the wheel.

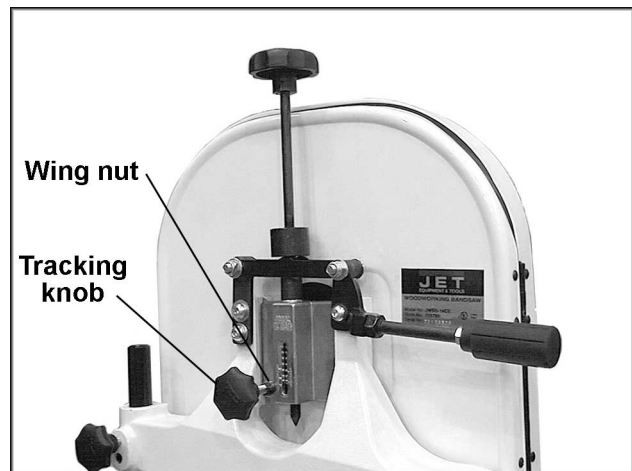

Fig. 17

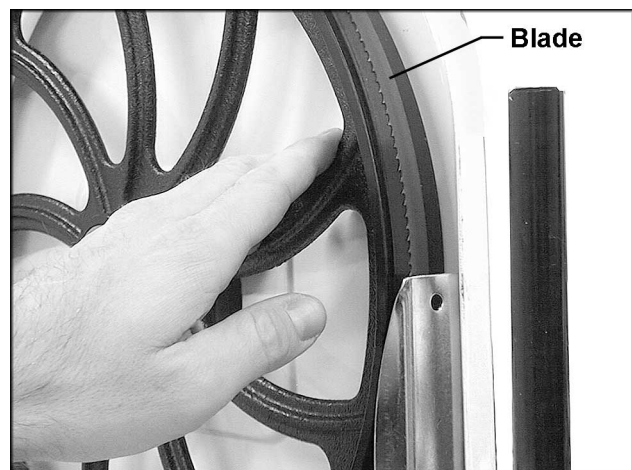

Fig. 17a

Adjusting Upper Blade Guide Assembly

1. **Disconnect machine from the power source.**
2. Loosen lock knob (A, Fig. 18) and raise or lower upper blade guide assembly (B, Fig. 18) to just above the material being cut.
3. Tighten lock knob. Make sure blade guide blocks (C, Fig. 18) are still flat to the blade. If adjustment is necessary, loosen lock knob (A, Fig. 18) and rotate assembly until guide blocks are flat to blade.
4. The upper blade guide is spring loaded. To adjust the tension on the spring, remove knob (A, Fig. 18), tighten or loosen set screw (D, Fig. 18) until desired tension is reached, and replace knob.

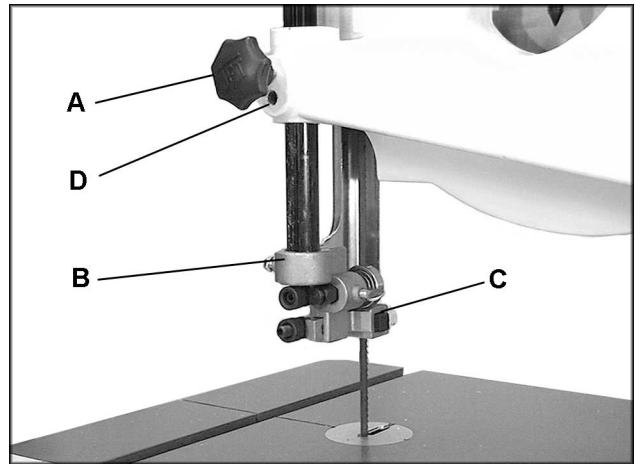

Fig. 18

Adjusting Upper Blade Guide and Blade Support Bearing

⚠ WARNING
Blade guard has been removed for picture clarity. Never operate the bandsaw without all guards in place and in working order! Failure to comply may cause serious injury!

1. **Disconnect machine from the power source.**
2. Blade must already be tensioned and tracking properly.
3. Loosen thumb screws (A, Fig. 19) and move guide blocks (B, Fig. 19) as close to the blade as possible without pinching it.
4. Tighten thumb screws (A, Fig. 19).
5. Loosen thumb screw (C, Fig. 19) and turn knurled knob (D, Fig. 19) to move the guide block bracket in or out until the front edge of the guide blocks are just behind the "gullets" of the saw teeth.
6. Tighten thumb screw (C, Fig. 19).
7. Loosen thumb screw (E, Fig. 19) and turn knurled knob (F, Fig. 19) to move the support bearing (G, Fig. 19) in or out until the bearing is 1/64" behind the blade.
8. Tighten thumb screw (E, Fig. 19).

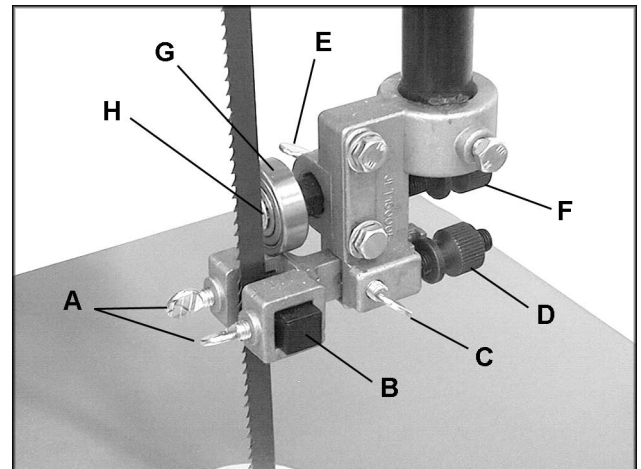

Fig. 19

9. The blade support bearing should be adjusted so that the back edge of the blade overlaps the front face of the ball bearing approximately 1/8". To change position of the bearing, remove screw (H, Fig. 19), and bearing (G, Fig. 19), and back off knurled knob (F, Fig. 19) completely to remove the bearing shaft. Notice the bearing holder on the shaft is eccentric. Re-install the bearing holder on the shaft is eccentric. Re-install the bearing shaft, the bearing, and the screw. Examine the overlap between the bearing face and the blade. Change the position of the bearing shaft until the overlap is approximately 1/8".

Adjusting Lower Blade Guides and Blade Support Bearing

1. **Disconnect machine from the power source.**
2. Blade must already be tensioned and tracking properly.
3. Loosen thumb screws (A, Fig. 20) and move guide blocks (B, Fig. 20) as close to blade as possible without pinching it.
4. Tighten thumb screws (A, Fig. 20).
5. Loosen thumb screw (C, Fig. 20) and turn knurled knob (D, Fig. 20) to move the guide block bracket in or out until the front edge of the guide blocks are just behind the "gullets" of the saw teeth.
6. Tighten thumb screw (C, Fig. 20).
7. Loosen thumb screw (E, Fig. 20) and turn knurled knob (F, Fig. 20) to move the support bearing (G, Fig. 20) in or out until the bearing is 1/64" behind the blade.
8. Tighten thumb screw (E, Fig. 20).
9. The blade support bearing should be adjusted so that the back edge of the blade overlaps the front face of the ball bearing approximately 1/8". To change position of the bearing, remove screw (H, Fig. 20) and bearing (G, Fig. 20), and back off knurled knob (F, Fig. 20) completely to remove the bearing shaft.
10. Notice the bearing holder on the shaft is eccentric. Re-install the bearing shaft, the bearing, and the screw. Examine the overlap between the bearing face and the blade. Change the position of the bearing shaft until the overlap is approximately 1/8". Re-tighten thumb screw (E, Fig. 20).

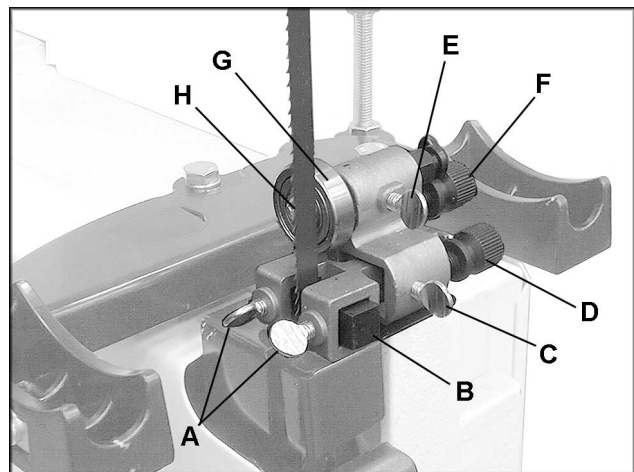

Fig. 20

TROUBLE-SHOOTING (JWBS-14DX Band Saw)

PROBLEM	POSSIBLE CAUSE	SOLUTION
Saw stops or will not start	<ol style="list-style-type: none"> 1. Saw unplugged 2. Fuse blown or circuit breaker tripped 3. Cord damaged 	<ol style="list-style-type: none"> 1. Check plug connections 2. Replace fuse or reset circuit breaker 3. Replace cord
Does not make accurate 45 deg. or 90 deg. cuts	<ol style="list-style-type: none"> 1. Stop not adjusted correctly 2. Angle pointer not set accurately 3. Miter gauge out of adjustment 	<ol style="list-style-type: none"> 1. Check blade with square and adjust stop 2. Check blade with square and adjust pointer 3. Adjust miter gauge
Blade wanders during cut	<ol style="list-style-type: none"> 1. Fence not aligned with blade 2. Warped wood 3. Excessive feed rate 4. Incorrect blade for cut 5. Blade tension not set properly 6. Guides not set properly 	<ol style="list-style-type: none"> 1. Check and adjust fence 2. Select another piece of wood 3. Reduce feed rate 4. Change blade to correct type 5. Set blade tension according to blade size 6. Adjust guides
Saw makes unsatisfactory cuts	<ol style="list-style-type: none"> 1. Dull blade 2. Blade mounted wrong 3. Gum or pitch on blade 4. Incorrect blade for cut 5. Gum or pitch on table 	<ol style="list-style-type: none"> 1. Replace blade 2. Teeth should point down 3. Remove blade and clean 4. Change blade to correct type 5. Clean table
Blade does not come up size and to speed	<ol style="list-style-type: none"> 1. Extension cord too light or too long 2. Low shop voltage 	<ol style="list-style-type: none"> 1. Replace with adequate length cord 2. Contact your local electric company
Saw vibrates excessively	<ol style="list-style-type: none"> 1. Base on uneven floor 2. Bad v-belt 3. Motor mount is loose 4. Loose hardware 	<ol style="list-style-type: none"> 1. Reposition on flat, level surface 2. Replace v-belt 3. Tighten motor mount hardware 4. Tighten hardware

Parts Breakdown

JWBS-14DX Body Assembly

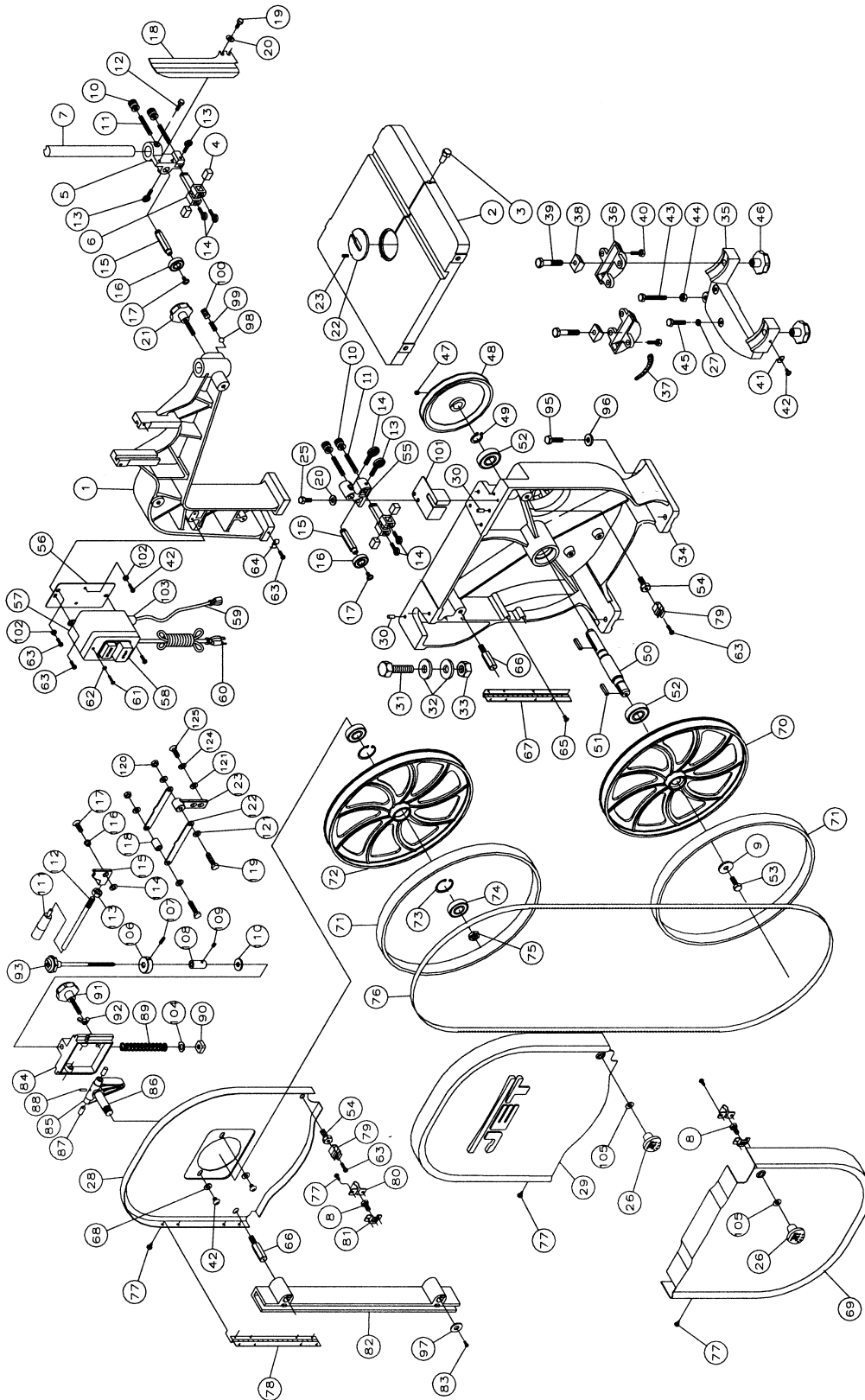

Parts List

JWBS-14DX Body Assembly

Index No.	Part No.	Description	Size	Qty.
1	JWBS14DX-101	Upper Arm Frame		1
2	150037W	Table		1
3	100038	Table Pin		1
4	708719	Guide Block		4
5	150005A	Upper Support Bracket Post		1
6	150006A	Support Bracket		2
7	150007A	Guide Post		1
8	TS-1490021	Hex Cap Screw	M8x16	2
9	TS-1550061	Flat Washer	M8	1
10	150010A	Nut		4
11	990708	Screw	M8x40	2
12	TS-1482031	Hex Cap Screw	M6x16	1
13	150013A	Thumb Screw	M6x16	3
14	150014A	Thumb Screw	M6x12	5
15	150015A	Upper Spacing Sleeve		2
16	BB-6200ZZ	Ball Bearing	6200ZZ	2
17	990908	Pan Head Screw*	M6x8	2
18	100002A	Upper Wheel Blade Guard		1
19	TS-148201	Hex Cap Screw	M6X10	2
20	TS-1550041	Flat Washer	M6	4
21	990651	Lock Knob	M10x30	1
22	199037	Table Insert		1
23	992311	Spring Pin		1
25	TS-1482041	Hex Cap Screw	M6x20	2
26	150024	Catch Knob		2
27	TS-1551061	Lock Washer*	M8	2(2)*
28	150028W	Inner Wheel Cover		1
29	155029W	Outer Wheel Cover		1
30	100031	Pin		4
31	990180	Hex Head Bolt	M16x55	1
32	WF164030	Washer	M16	2
33	TS-1540101	Hex Nut	M16	1
34	JWBS14DX-134	Base		1
35	110045	Trunnion Support Bracket		1
36	100042	Trunnion		2
37	100051	Scale		1
38	100041	Trunnion Clamp Shoe		2
39	TS-1491081	Hex Cap Screw	M10x50	2
40	TS-1482021	Hex Cap Screw	M6x12	6
41	110049	Pointer		1
42	990821	Pan Head Screw	M5x6	5
43	TS-1490151	Hex Cap Screw*	M8x80	1
44	TS-1540061	Nut*	M8	1
45	TS-1490051	Hex Cap Screw*	M8X30	2
46	990554	Lock Knob		2
47	TS-152303	Socket Set Screw	M6x10	1
48	100063	Belt Pulley		1
49	992547	Retaining Ring		1
50	110065	Lower Wheel Shaft		1

Parts List

JWBS-14DX Body Assembly

Index No.	Part No.	Description	Size	Qty.
51	992009	Key	5x5x20	2
52	BB-6204RS	Ball Bearing	6204RS	2
53	990293	Hex Head Bolt (Left Thread)	M8x25	1
54	150054	Hex Head Bolt		2
55	150055	Lower Support Bracket Post		1
56	150056	Switch Backing Plate		1
57	523028	Switch Box		1
58	994542	Switch		1
59	995001	Power Cord (Switch To Motor)		1
60	995002	Power Cord (Switch To Power Soure)		1
61	990814	Self Tapping Screw	M3.5x19	2
62	TS-1550021	Flat Washer	M4	2
63	TS-1533042	Phillips Pan Head Machine Screw	M5x12	6
64	523024	Wire Clip		1
65	TS-1533032	Phillips Pan Head Machine Screw	M5x10	4
66	150066	Stud		2
67	150902	Lower Hinge		1
68	WF051210	Washer	M5	2
69	JWBS14DX-169	Lower Wheel Guard		1
70	100185	Lower Wheel		1
71	100025A	Wheel Protector		2
72	100186	Upper Wheel		1
73	992522	Retaining Ring	R35	2
74	BB-6202ZZ	Ball Bearing	6202ZZ	2
75	TS-1540083	Hex Nut	M12x1.25	1
76		Saw Blade (Local Purchase)		1
77	990804	Self Tapping Screw	M4x8	16
78	150901	Upper Hinge		1
79	150079	Catch		2
80	150080	Clip		2
81	150081	Bracket		2
82	110070	Blade Guard		1
83	990811	Self Tapping Screw	M3.5x12	2
	JWBS14DX-SBA	Sliding Bracket Assy (items 84 thru 93,104, and 106 thru 110)		
84	100016A	Sliding Bracket		1
85	100019	Shaft Hinge		1
86	150086	Upper Wheel Shaft		1
87	100021	Steel Pin		2
88	992314	Spring Pin		1
89	100015A	Coil Spring		1
90	150090	Square Nut		1
91	990652	Lock Knob		1
92	NW080000	Wing Nut	M8	1
93	JWBS14DX-193	Blade Adjusting Screw		1
95	TS-1490071	Hex Cap Screw*	M8x40	4
96	TS-1550061	Flat Washer*	M8	4
97	150097	Washer		2
98	994181	Steel Ball		1
99	150099	Spring		1
100	TS-1525011	Socket Set Screw	M10x10	1

Parts List

JWBS-14DX Body Assembly

Index No.	Part No.	Description	Size	Qty.
101.....	150101	Lower Wheel Blade Guard		1
102.....	WE050000	Gear Washer	M5	2
103.....	998654	Strain Relief		2
104.....	100018	Indicator		1
105.....	WI080000.....	Gear Washer	M8	2
106.....	100174	Fixed Collar		1
107.....	TS-1522031.....	Socket Set Screw.....	M5x10.....	1
108.....	130044	Fixed Collar		1
109.....	SS050100.....	Socket Set Screw.....	M5x5.....	1
110.....	TS-1550071.....	Flat Washer	M10.....	1
111.....	100234	Tension Lever Knob	M8	1
112.....	100183	Tension Lever Rod.....		1
113.....	NH121900	Hex Nut.....	M12.....	1
114.....	100205	Gasket	M8	1
115.....	100182	Tension Lever		1
116.....	100176	Bushing.....		1
117.....	TS-2248202.....	Socket Head Button Screw.....	M8x20.....	1
118.....	100177	Spacer		1
119.....	TS-1490071.....	Hex Cap Screw	M8x40.....	2
120.....	TS-1541031.....	Nylon Lock Hex Nut	M8	2
121.....	TS-1550061.....	Flat Washer	M8	6
122.....	100178	Support Plate		2
123.....	100179	Fixed Base.....		1
124.....	TS-2361081.....	Lock Washer.....	M8	2
125.....	TS-2248202.....	Socket Head Button Screw.....	M8x20.....	2
	JWBS14-HK.....	Hardware Kit (not shown)		1

* included in hardware kit

Parts Breakdown

JWBS-14DX Closed Stand Assembly

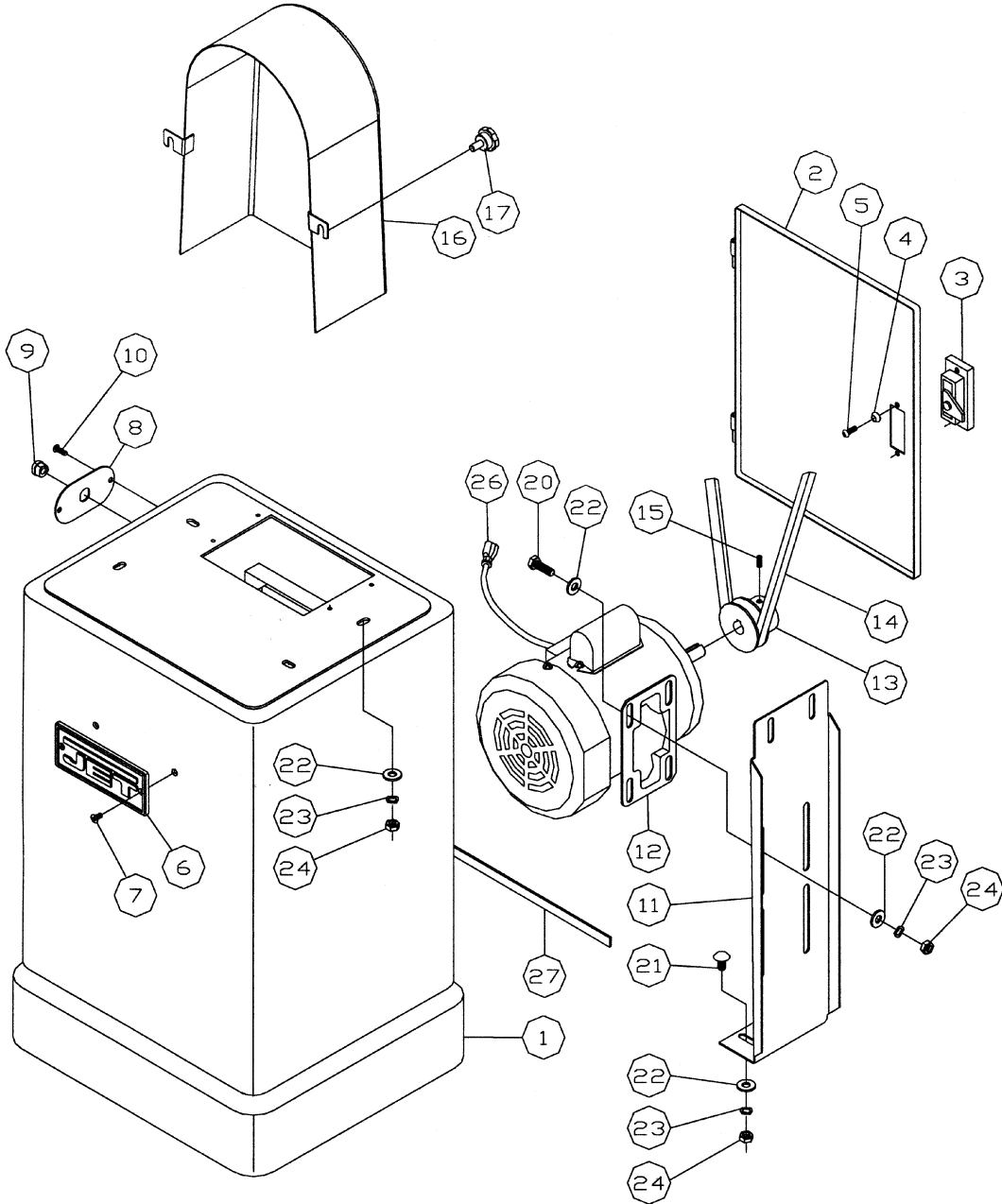

Parts List

JWBS-14DX Closed Stand Assembly

Index No.	Part No.	Description	Size	Qty.
1	150501W	Stand		1
2	150502W	Door		1
3	150503	Door Latch Assembly (Items 4 & 5)		1
4	WBS14CS-04	Washer		2
5	WBS14CS-05	Pan Head Screw	M4x5	2
6	PG-M02	Plaque		1
7	TS-1533031	Flat Head Screw	M5x10	2
8	150508W	Plate		1
9	998621	Stran Relief		1
10	TS-1533042	Pan Head Screw*	M5x12	2
11	150511W	Motor Plate		1
12	100180	Motor (TEFC)	1-1/4 HP, 1Ph, 115/230V	1
13	600013	Motor Pulley		1
14	VB-A50	V-Belt		1
15	TS-1523011	Set Screw	M6x6	1
16	100254	Belt Cover		1
17	PWBS14-306	Knob*	M6x12	2
20	TS-1490041	Hex Head Bolt	M8x25	4
21	991516	Square Neck Bolt	M8x16	4
22	TS-1550051	Washer*	M8	16(4)*
23	TS-155108	Lock Washer*	M8	12(4)*
24	TS-1540061	Nut*	M8	12(4)*
26	995003A	Motor Cord		1
27	150527	Pad		2
	WBS14CS-HK	Hardware Kit (includes items marked with *)		1

Optional Accessories for JWBS-14DX Band Saw

- 708114 **Three speed kit for WBS-14CS**
Produces speeds of 965, 1470, and 2465 SPFM. Includes four step motor pulley, intermediate pulley, V-belts, fasteners, and mounting instructions with parts list.
- 708718 **JRF-14 Rip Fence Assembly**
Includes guide bars, rip fence assembly, fasteners, and mounting instructions with parts list.
- 708717 **JRB-14 Riser Block Kit**
Increases depth of cut from 6" maximum to 12" maximum. Includes 6" cast block, long frame bolt, front and back blade guards, and mounting instructions with parts list. (Blade not included - requires 105-1/2" blade).
- 708716 **JMG-14 Miter Gauge Assembly**
For straight and angle cutting. Includes guide bar, pivoting support body, and adjustable stops.
- 708719 **JRB-14 Blade Block Set**
Includes upper and lower replacement blocks made from a non-metallic composite material with a dry lubricant to reduce friction and heat.

JWBS-14DX Electrical Schematic – 115V

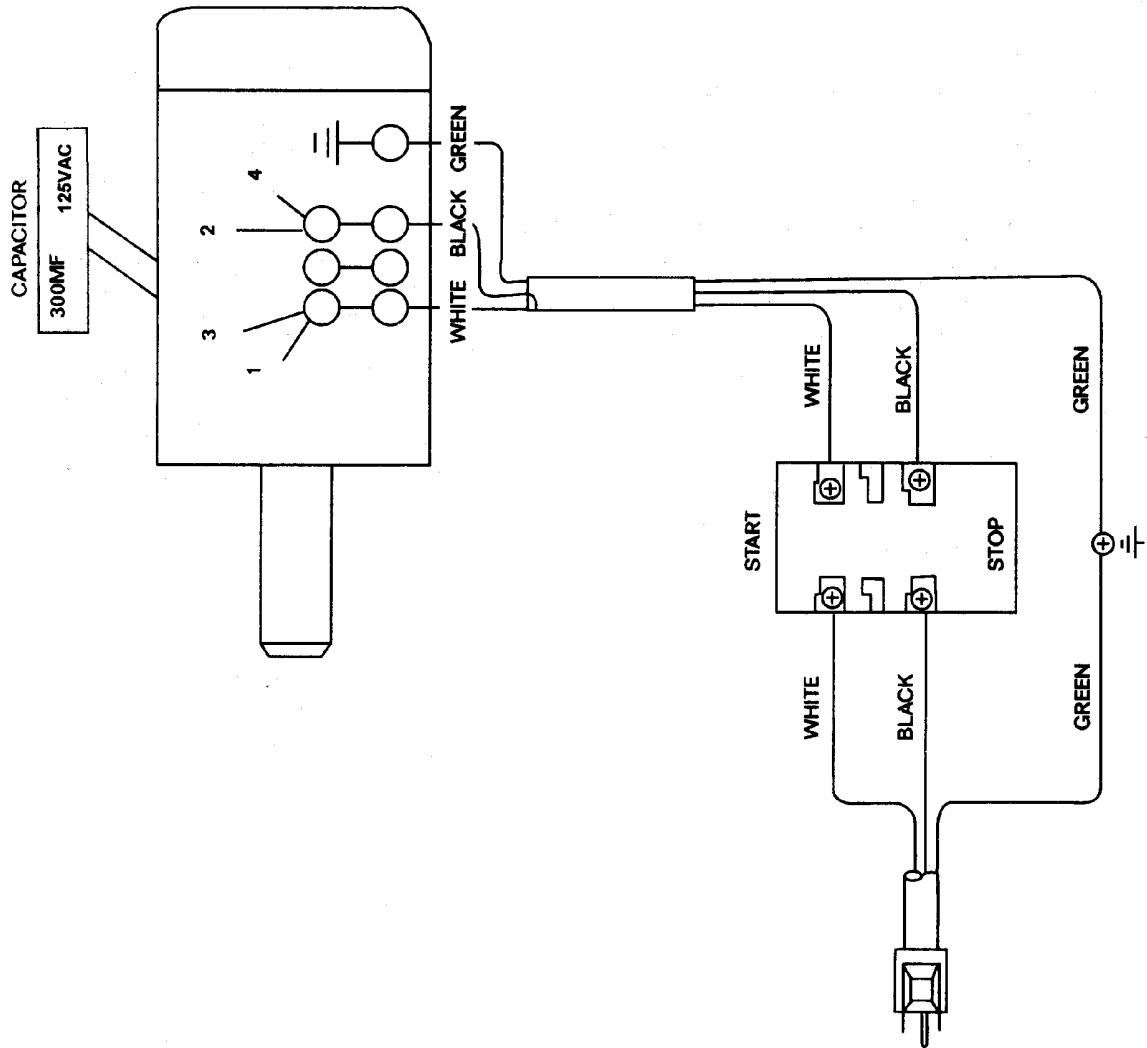

JWBS-14DX Electrical Schematic - 230V

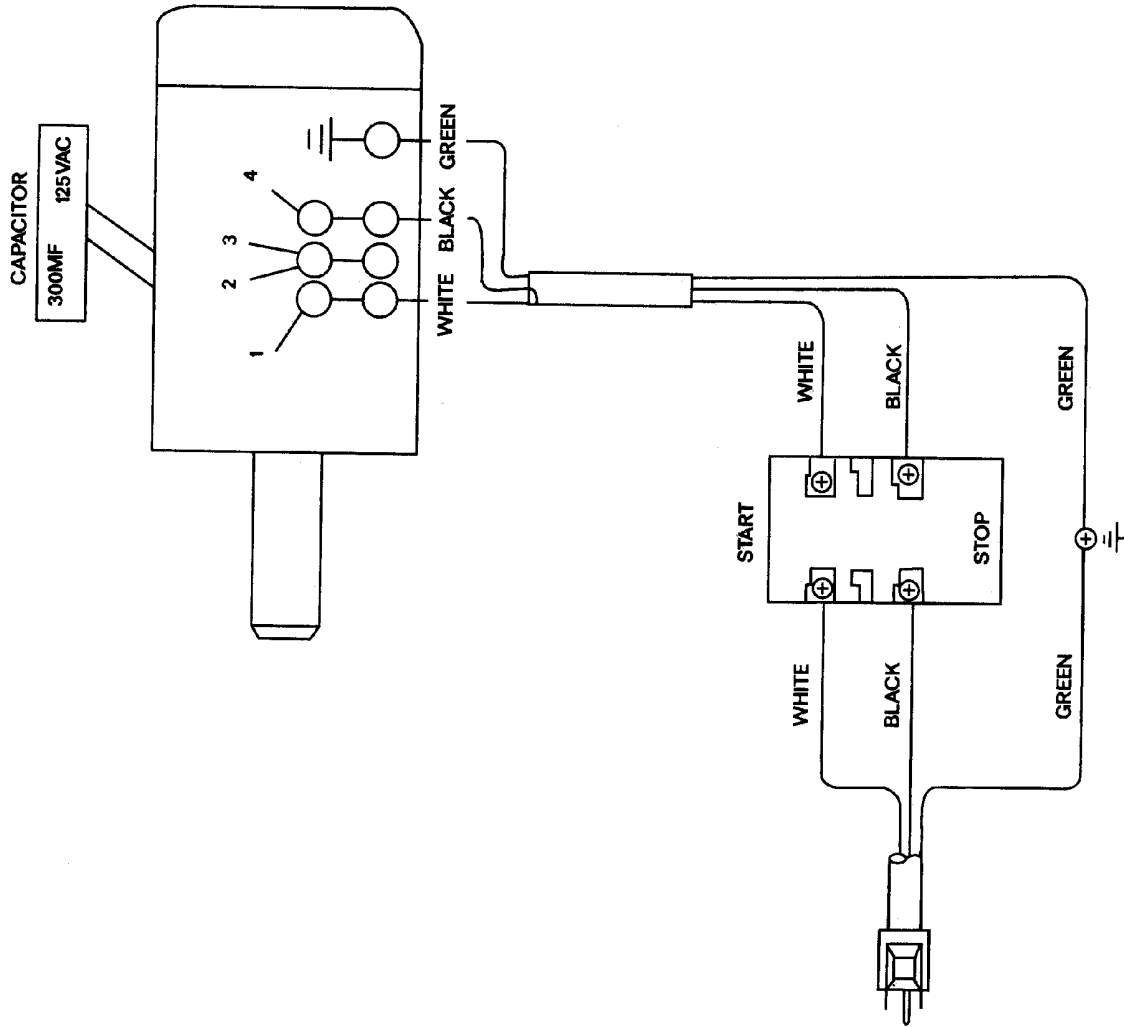

JET[®]

WMH TOOL GROUP
2420 Vantage Drive
Elgin, IL 60123
Ph: 800-274-6848
www.wmhtoolgroup.com