

14" Wood Cutting Band Saw (Model 28-275)

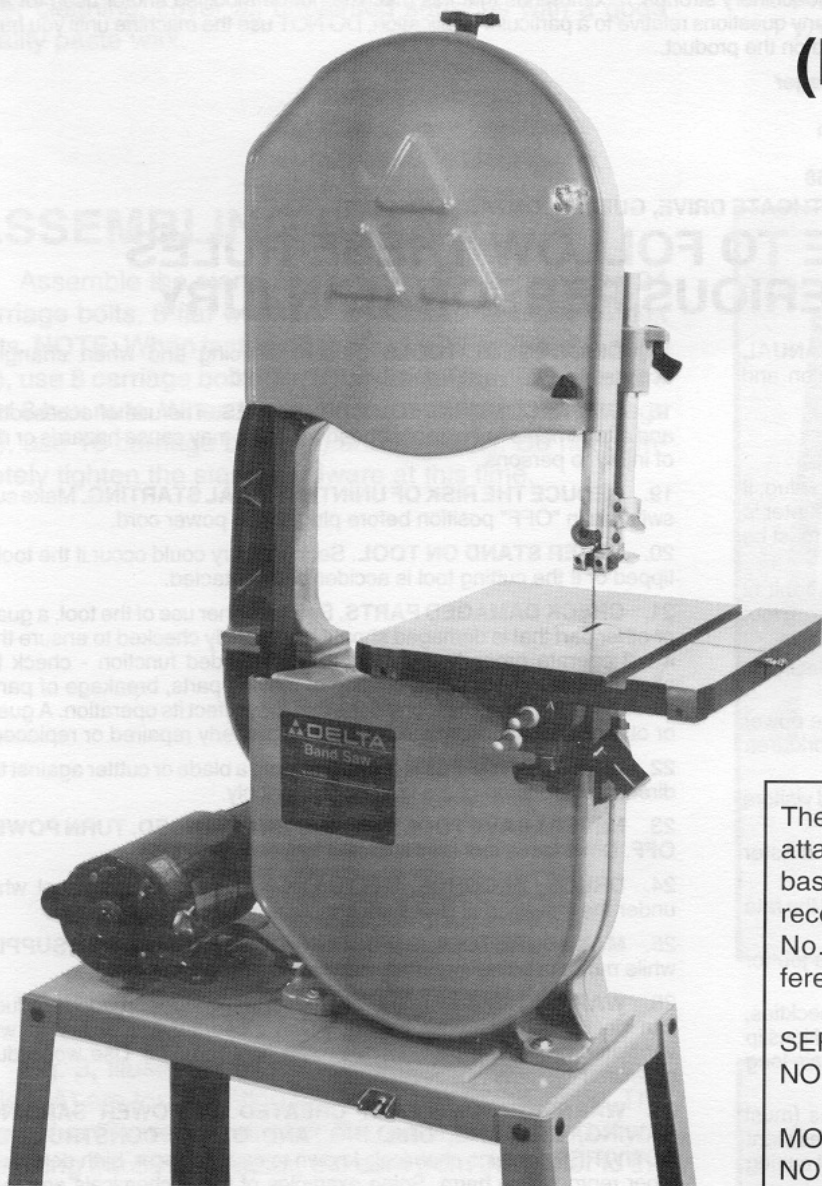

The Serial No. / Model No. plate is attached to the right side of the base casting. Locate this plate and record the Serial No. and Model No. in your manual for future reference.

SERIAL
NO. _____

MODEL
NO. _____

REVISED 7-20-00

PART NO. 426-02-651-0026

© Delta International Machinery Corp. 1999



DELTA

MACHINERY

SAFETY RULES

Woodworking can be dangerous if safe and proper operating procedures are not followed. As with all machinery, there are certain hazards involved with the operation of the product. Using the machine with respect and caution will considerably lessen the possibility of personal injury. However, if normal safety precautions are overlooked or ignored, personal injury to the operator may result. Safety equipment such as guards, push sticks, hold-downs, featherboards, goggles, dust masks and hearing protection can reduce your potential for injury. But even the best guard won't make up for poor judgment, carelessness or inattention. Always use common sense and exercise caution in the workshop. If a procedure feels dangerous, don't try it. Figure out an alternative procedure that feels safer. **REMEMBER:** Your personal safety is your responsibility.

This machine was designed for certain applications only. Delta Machinery strongly recommends that this machine not be modified and/or used for any application other than that for which it was designed. If you have any questions relative to a particular application, **DO NOT** use the machine until you have first contacted Delta to determine if it can or should be performed on the product.

Technical Service Manager
Delta Machinery
4825 Highway 45 North
P.O. Box 2468
Jackson, TN 38302-2468
(IN CANADA: 505 SOUTHGATE DRIVE, GUELPH, ONTARIO N1H 6M7)

WARNING: FAILURE TO FOLLOW THESE RULES MAY RESULT IN SERIOUS PERSONAL INJURY

- FOR YOUR OWN SAFETY, READ INSTRUCTION MANUAL BEFORE OPERATING THE TOOL.** Learn the tool's application and limitations as well as the specific hazards peculiar to it.
- KEEP GUARDS IN PLACE** and in working order.
- ALWAYS WEAR EYE PROTECTION.**
- GROUND ALL TOOLS.** If tool is equipped with three-prong plug, it should be plugged into a three-hole electrical receptacle. If an adapter is used to accommodate a two-prong receptacle, the adapter lug must be attached to a known ground. Never remove the third prong.
- REMOVE ADJUSTING KEYS AND WRENCHES.** Form habit of checking to see that keys and adjusting wrenches are removed from tool before turning it "on."
- KEEP WORK AREA CLEAN.** Cluttered areas and benches invite accidents.
- DON'T USE IN DANGEROUS ENVIRONMENT.** Don't use power tools in damp or wet locations, or expose them to rain. Keep work area well-lighted.
- KEEP CHILDREN AND VISITORS AWAY.** All children and visitors should be kept a safe distance from work area.
- MAKE WORKSHOP CHILDPROOF** - with padlocks, master switches, or by removing starter keys.
- DON'T FORCE TOOL.** It will do the job better and be safer at the rate for which it was designed.
- USE RIGHT TOOL.** Don't force tool or attachment to do a job for which it was not designed.
- WEAR PROPER APPAREL.** No loose clothing, gloves, neckties, rings, bracelets, or other jewelry to get caught in moving parts. Non-slip footwear is recommended. Wear protective hair covering to contain long hair.
- ALWAYS USE SAFETY GLASSES.** Wear safety glasses (must comply with ANSI Z87.1). Everyday eyeglasses only have impact resistant lenses; they are not safety glasses. Also use face or dust mask if cutting operation is dusty.
- SECURE WORK.** Use clamps or a vise to hold work when practical. It's safer than using your hand and frees both hands to operate tool.
- DON'T OVERREACH.** Keep proper footing and balance at all times.
- MAINTAIN TOOLS IN TOP CONDITION.** Keep tools sharp and clean for best and safest performance. Follow instructions for lubricating and changing accessories.
- DISCONNECT TOOLS** before servicing and when changing accessories such as blades, bits, cutters, etc.
- USE RECOMMENDED ACCESSORIES.** The use of accessories and attachments not recommended by Delta may cause hazards or risk of injury to persons.
- REDUCE THE RISK OF UNINTENTIONAL STARTING.** Make sure switch is in "OFF" position before plugging in power cord.
- NEVER STAND ON TOOL.** Serious injury could occur if the tool is tipped or if the cutting tool is accidentally contacted.
- CHECK DAMAGED PARTS.** Before further use of the tool, a guard or other part that is damaged should be carefully checked to ensure that it will operate properly and perform its intended function - check for alignment of moving parts, binding of moving parts, breakage of parts, mounting, and any other conditions that may affect its operation. A guard or other part that is damaged should be properly repaired or replaced.
- DIRECTION OF FEED.** Feed work into a blade or cutter against the direction of rotation of the blade or cutter only.
- NEVER LEAVE TOOL RUNNING UNATTENDED. TURN POWER OFF.** Don't leave tool until it comes to a complete stop.
- DRUGS, ALCOHOL, MEDICATION.** Do not operate tool while under the influence of drugs, alcohol or any medication.
- MAKE SURE TOOL IS DISCONNECTED FROM POWER SUPPLY** while motor is being mounted, connected or reconnected.
- WARNING:** The dust generated by certain woods and wood products can be injurious to your health. Always operate machinery in well ventilated areas and provide for proper dust removal. Use wood dust collection systems whenever possible.
- WARNING: SOME DUST CREATED BY POWER SANDING, SAWING, GRINDING, DRILLING, AND OTHER CONSTRUCTION ACTIVITIES** contains chemicals known to cause cancer, birth defects or other reproductive harm. Some examples of these chemicals are: lead from lead-based paints; crystalline silica from bricks and cement and other masonry products, and arsenic and chromium from chemically-treated lumber. Your risk from these exposures varies, depending on how often you do this type of work. To reduce your exposure to these chemicals: work in a well ventilated area, and work with approved safety equipment, such as those dust masks that are specially designed to filter out microscopic particles.

ADDITIONAL SAFETY RULES FOR BAND SAWS

- ADJUST** the upper guide about 1/8" above the material being cut.
- MAKE SURE** that blade tension and blade tracking are properly adjusted.
- STOP** the machine before removing scrap pieces from the table.
- ALWAYS** keep hands and fingers away from blade.
- CHECK** for proper blade size and type.
- DO NOT** attempt to saw stock that does not have a flat surface, unless a suitable support is used.
- HOLD** material firmly and feed into blade at a moderate speed.
- TURN OFF** machine if the material is to be backed out of an uncompleted cut.
- MAKE** "release" cuts before cutting long curves.
- ADDITIONAL INFORMATION** regarding the safe and proper operation of this product is available from the National Safety Council, 1121 Spring Lake Drive, Itasca, IL 60143-3201 in the Accident Prevention Manual for Industrial Operations and also in the Safety Data Sheets provided by the NSC. Please also refer to the American National Standards Institute ANSI 01.1 Safety Requirements for Woodworking Machinery and the U.S. Department of Labor OSHA 1910.213 Regulations.

UNPACKING AND CLEANING

Carefully unpack the band saw, stand, and all loose items from the cartons. Remove the protective coating from the machined surfaces of the band saw. This coating may be removed with a soft cloth moistened with kerosene (do not use acetone, gasoline or lacquer thinner for this purpose.) After cleaning, cover all unpainted surfaces with a good quality paste wax.

TOOLS NEEDED FOR ASSEMBLY

Your band saw can be assembled using a few basic hand tools including:

| | |
|----------------------|------------------------|
| Screwdriver | 1/2" Wrench |
| Phillips screwdriver | 9/16" Wrench |
| 7/16" Wrench | Hex Key (Allen) Wrench |

ASSEMBLING STAND

1. Assemble the stand as shown in Fig. 2, using the 24 carriage bolts, 8 flat washers, 8 lockwashers and 24 hex nuts. **NOTE:** When fastening the legs (C) Fig. 2, to the shelf (E), use 8 carriage bolts (F), 8 flat washers, 8 lockwashers and 8 hex nuts. When fastening the tie bars (G) to the legs (C), use 16 carriage bolts (H) and hex nuts. Do not completely tighten the stand hardware at this time.

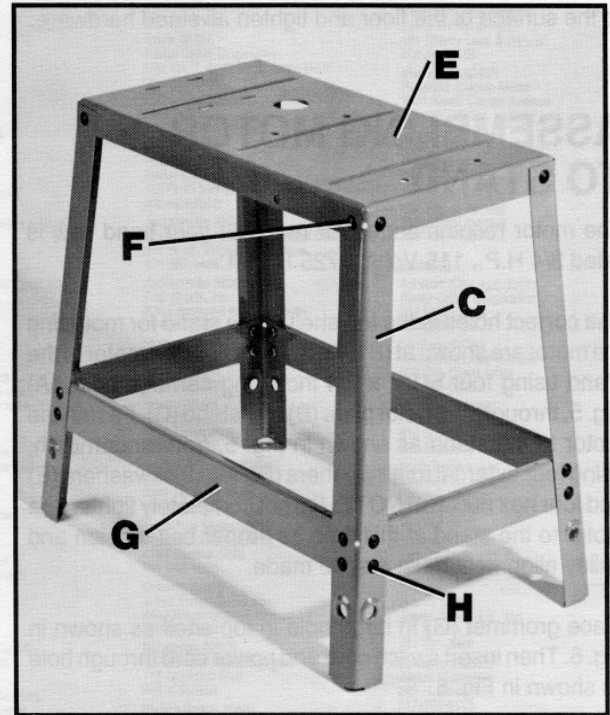

Fig. 2

2. Fig. 3, illustrates the top shelf of the stand. The four holes (A) are for mounting the band saw to the stand. The four holes (B) are for mounting the motor to the stand. If you are using the 62-158 motor, the cord from the motor to the power supply and the cord from the motor to the switch are to be passed through the large hole (D) Fig. 3.

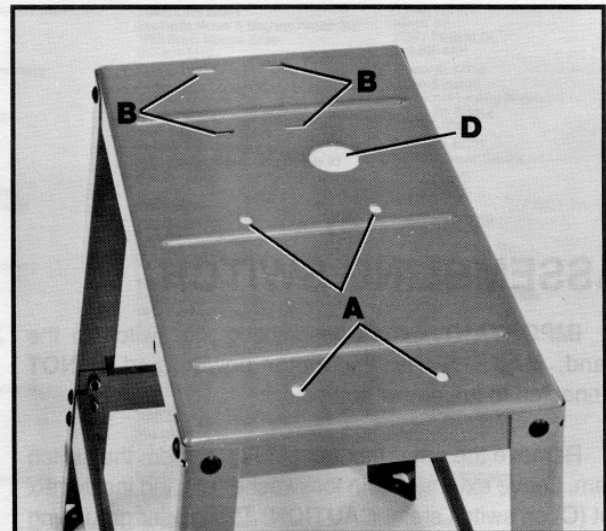

Fig. 3

ASSEMBLING BAND SAW TO STAND

The correct holes in the top shelf of the stand for mounting the band saw are shown at (A) Fig. 3. Assemble the band saw to the stand, as shown in Fig. 4, using the four 5/16-18 x 1-3/4" hex head screws, 5/16" flat washers, 5/16" lockwashers and 5/16"-18 hex nuts. The hex nuts and lockwashers will be located on the underside of the top shelf. Push down on top of stand so the legs of stand adjust to the surface of the floor and tighten all stand hardware.

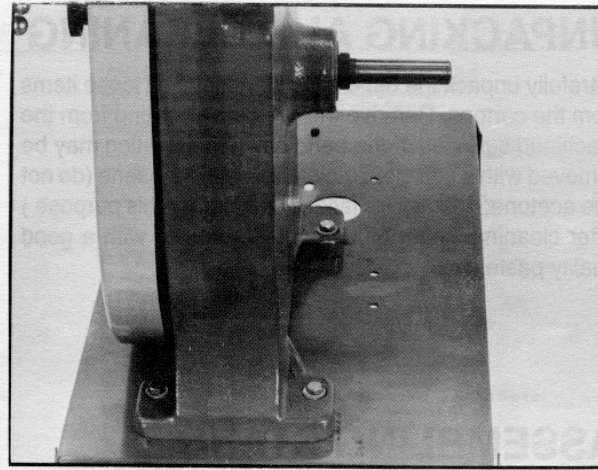

Fig. 4

ASSEMBLING MOTOR TO STAND

The motor recommended for use with your band saw is rated 3/4 H.P., 115 Volts, 1725 R.P.M.

The correct holes in the top shelf of the stand for mounting the motor are shown at (B) Fig. 3. Assemble the motor to the stand using four 5/16" x 3/4 inch-long carriage bolts (A) Fig. 5, through the motor plate (B) and stand (C). Fasten the motor to the stand as shown in Fig. 5, from underneath, using four external tooth washers (D), four lockwashers (E) and four hex nuts (F). **NOTE:** Do not completely tighten the motor to the stand at this time as proper belt tension and pulley alignment must first be made.

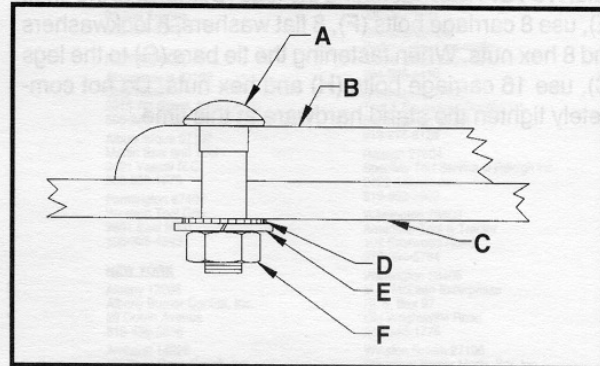

Fig. 5

Place grommet (G) in large hole in top shelf as shown in Fig. 6. Then insert switch cord and power cord through hole as shown in Fig. 6.

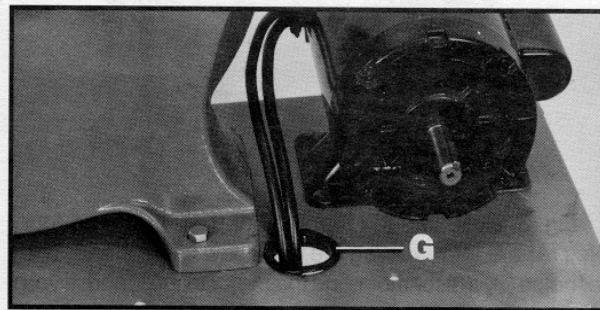

Fig. 6

ASSEMBLING SWITCH

1. **IMPORTANT:** When assembling the switch to the stand, **MAKE SURE** the motor power cord is **NOT** connected to the power source.

2. Remove the outer hex nut (A) Fig. 7, from the switch stem. Leave external tooth lockwasher (B) and inside hex nut (C) on switch stem. **CAUTION:** The proper grounding of the switch to prevent shock hazard, depends on the use of the external tooth lockwasher in the manner shown.

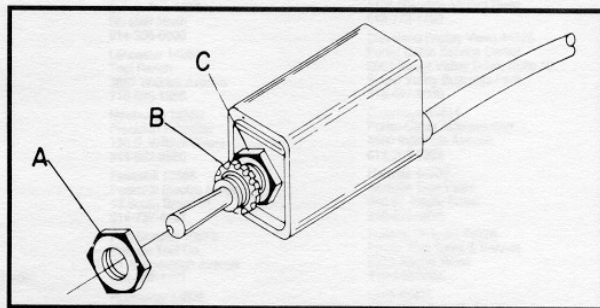

Fig. 7

3. Insert switch stem through hole in the side of top shelf of the stand, making sure the keyway in the switch stem is in the down position.

4. Place the switch bracket (D) Fig. 8, on switch stem with key of switch bracket engaged with keyway in switch stem. Fasten switch in place with hex nut (A) that was removed in STEP 2. **NOTE:** The excess wire from the motor to the switch should be wrapped and tied and then positioned out of the way.

5. **IMPORTANT:** It is recommended that when the band saw is not in use, the switch be locked in the "OFF" position using a padlock. Catalog No. 49-031 Padlock is available as an accessory.

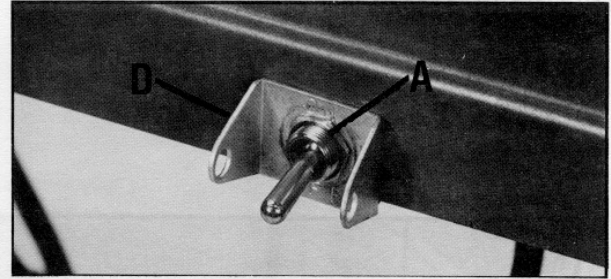

Fig. 8

ASSEMBLING BELT GUARD, MOTOR AND ARBOR PULLEYS, AND DRIVE BELT

1. Thread the six self-tapping screws (A) Fig. 9, about halfway into the six holes provided in the ledge of the inside belt and pulley guard (B) as shown.

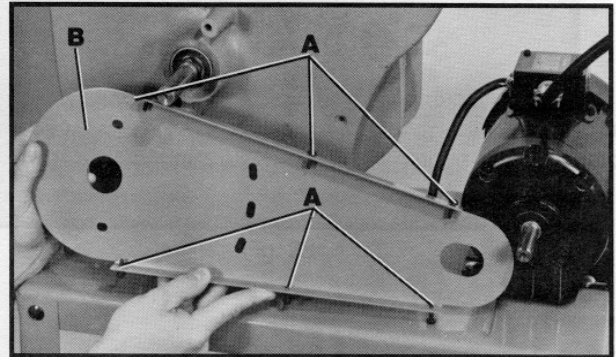

Fig. 9

2. Assemble the inside belt and pulley guard (B) Fig. 10, over the arbor and motor shafts as shown and fasten the guard to the machine using the two 1/2 inch-long hex head cap screws and flat washers (C). **NOTE:** Do not completely tighten the screws at this time.

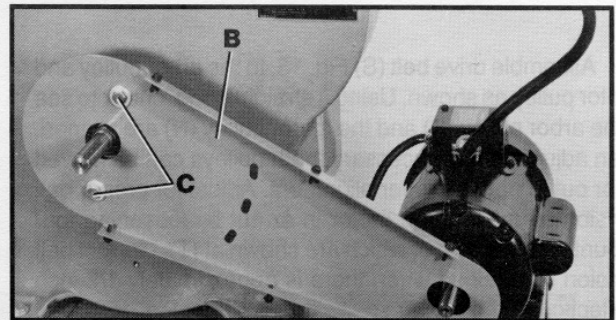

Fig. 10

3. Place the spacer (D) Fig. 11, into the countersunk hole (E) located behind the belt and pulley guard (B). Then insert the 2-3/4 inch hex head cap screw with flat washer (F) into the center hole (G), through the spacer (D) and thread it into the tapped hole (E).

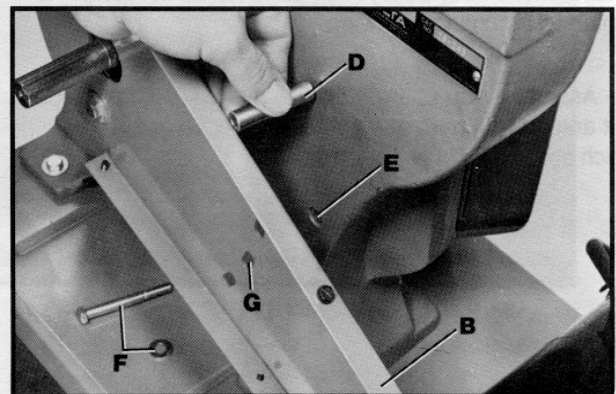

Fig. 11

4. **NOTE:** Make certain the arbor shaft (H) Fig. 12, and motor shaft (J) are centered in the holes of the belt and pulley guard (B) as shown, then tighten screws (C) and (F).

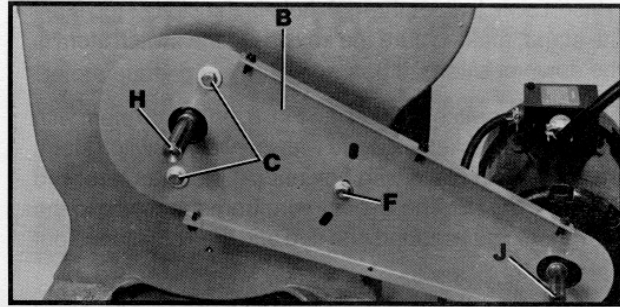

Fig.12

5. Assemble the arbor pulley (K) Fig. 13, to arbor shaft with hub of pulley in the "out" position. Insert key (L) in keyway of arbor shaft and tighten set screw (M).

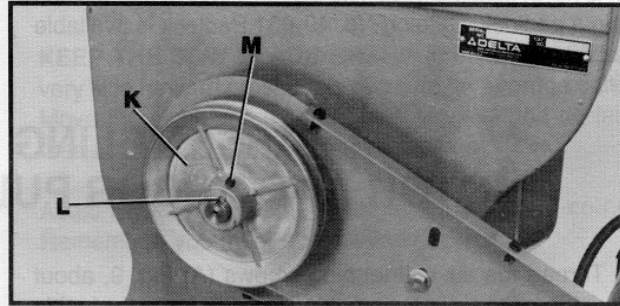

Fig.13

6. Assemble motor pulley (N) Fig. 14, to motor shaft with hub of pulley in the "in" position. Insert key (P) in keyway of motor shaft and tighten set screw (R) in motor pulley

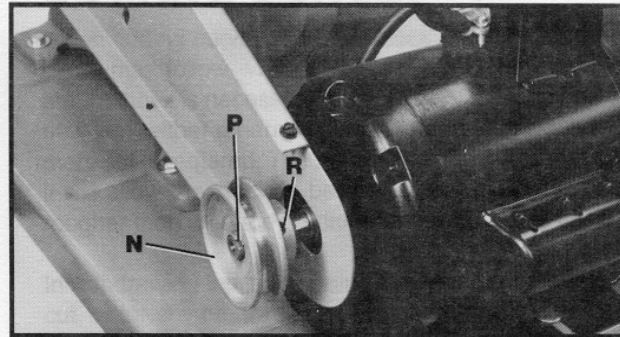

Fig.14

7. Assemble drive belt (S) Fig. 15, to the arbor pulley and motor pulley as shown. Using a straight edge, check to see if the arbor pulley (K) and the motor pulley (N) are aligned. If an adjustment is necessary, both pulleys can be moved in or out to obtain proper alignment. Adjust for proper belt tension by moving the motor in or out by loosening four mounting bolts, two of which are shown at (T). Correct belt tension is obtained when there is approximately 1/2 inch deflection at the center span of the belt (S) Fig. 15, using light finger pressure. **NOTE:** When proper belt tension is obtained and both pulleys are aligned, make certain to tighten all mounting hardware.

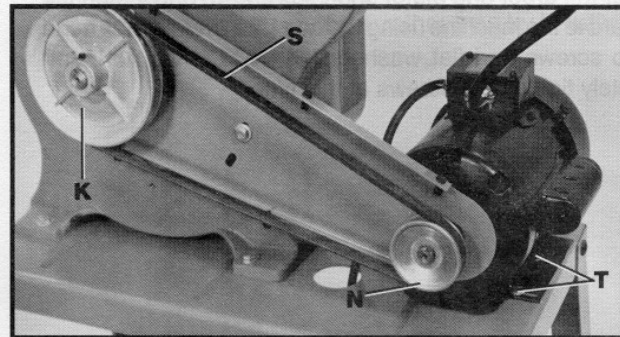

Fig.15

8. Assemble outer belt and pulley guard (V) to the inside belt and pulley guard and tighten the six screws, three of which are shown at (A) Fig. 16.

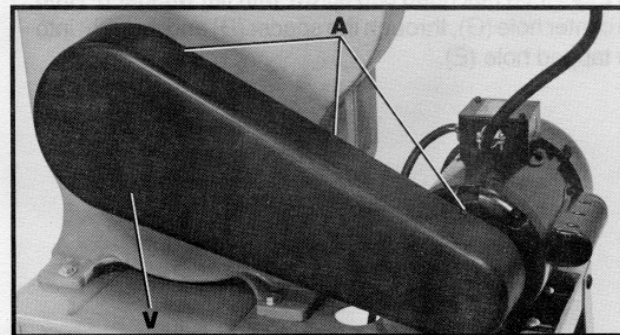

Fig.16

CONNECTING BAND SAW TO POWER SOURCE

POWER CONNECTIONS

A separate electrical circuit should be used for your power tools. This circuit should not be less than #12 wire and should be protected with a 20 Amp time lag fuse. If an extension cord is used, use only 3-wire extension cords which have 3-prong grounding type plugs and 3-pole receptacles which accept the tools plug. For distances up to 100 feet use #12 wire. For distances up to 150 feet use #10 wire. Before connecting the motor to the power line, make sure the switch is in the "OFF" position and be sure that the electric current is of the same characteristics as stamped on motor nameplate. All line connections should make good contact. Running on low voltage will injure the motor. Have a registered electrician replace or repair damaged or worn cords immediately.

GROUNDING INSTRUCTIONS

CAUTION: This tool must be grounded while in use, to protect the operator from electric shock. The motor is shipped wired for 115 Volt, Single Phase and is equipped with an approved 3-conductor cord and 3-prong grounding type plug to fit the proper grounding type receptacle, as shown in Fig. 17. The green conductor in the cord is the grounding wire. **CAUTION: Never connect the green wire to a live terminal.**

An adapter, shown in Fig. 18, is available for connecting 3-prong grounding type plugs to 2-prong receptacles. **THIS ADAPTER IS NOT APPLICABLE IN CANADA.** The green-colored rigid ear, lug, etc., extending from the adapter is the grounding means and must be connected to a permanent ground such as to a properly grounded outlet box, as shown in Fig. 18.

CAUTION: IN ALL CASES, MAKE SURE THE RECEPTACLE IN QUESTION IS PROPERLY GROUNDED. IF YOU ARE NOT SURE, HAVE A CERTIFIED ELECTRICIAN CHECK THE RECEPTACLE.

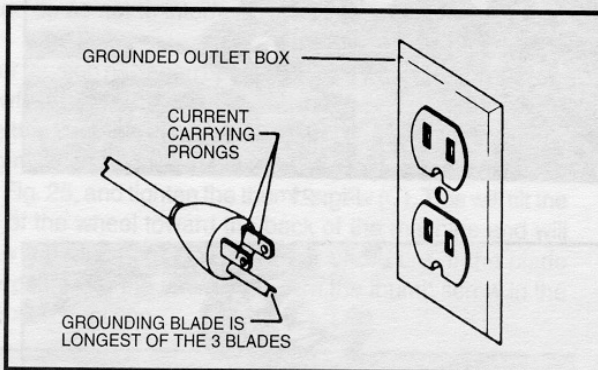

Fig. 17

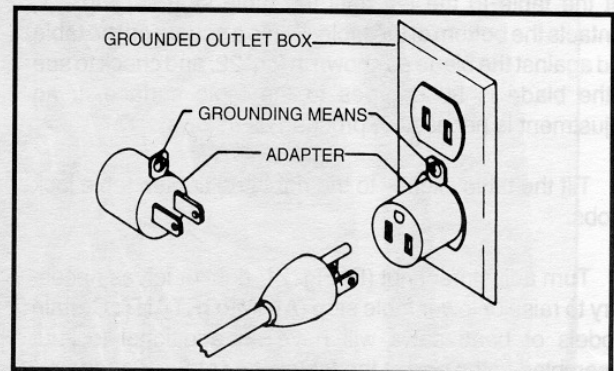

Fig. 18

TABLE INSERT

Place table insert (A) Fig. 19, in the hole provided in the table, making sure the pin (B) in the table engages one of the indents in the table insert.

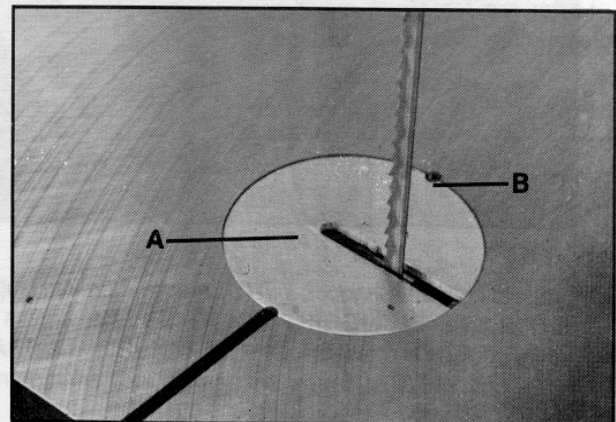

Fig. 19

TILTING THE TABLE

The table on your band saw can be tilted 45 degrees to the right and 10 degrees to the left. To tilt the table, loosen the two knobs (A) Fig. 20; tilt the table to the desired angle and tighten the two knobs (A).

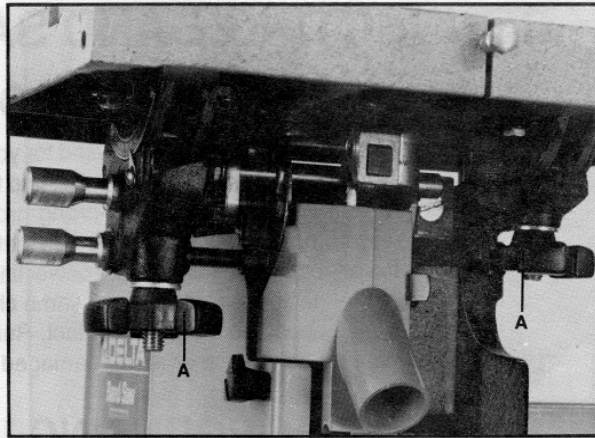

Fig. 20

ADJUSTING TABLE STOP

The band saw is equipped with an adjustable table stop (A) Fig. 21, that allows the table to be set perfectly at 90 degrees with the blade.

Tilt the table to the left until the table stop (A) Fig. 21, contacts the bottom of the table. Place a square on the table and against the blade as shown in Fig. 22, and check to see if the blade is 90 degrees to the table surface. If an adjustment is necessary, proceed as follows:

1. Tilt the table slightly to the right and tighten table lock knobs.
2. Turn adjustment nut (B) Fig. 21, right or left as necessary to raise or lower table stop (A). **IMPORTANT:** Certain models of band saws will have an additional locknut assembled to the end of the table stop (A) Fig. 21, directly under casting (C). Loosen locknut and turn adjustment nut (B) right or left as needed to raise or lower the table stop (A). Tighten locknut after adjustment is made.
3. Lower the table and make certain the table is 90 degrees to the blade as shown in Fig. 22.
4. It is necessary to remove the adjustable table stop (A) Fig. 21, when tilting the table to the left.

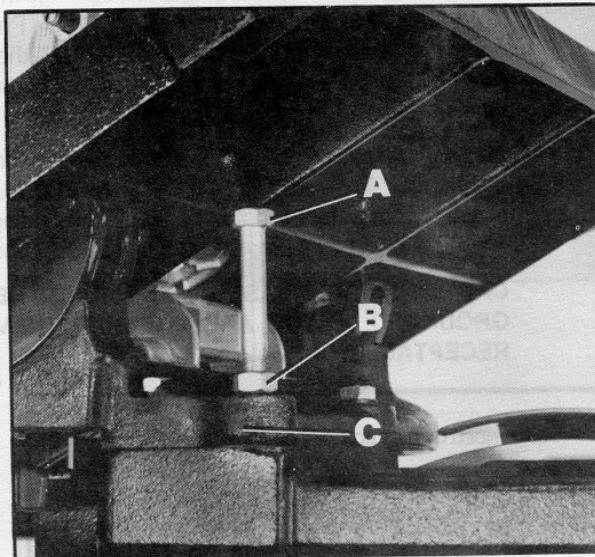

Fig. 21

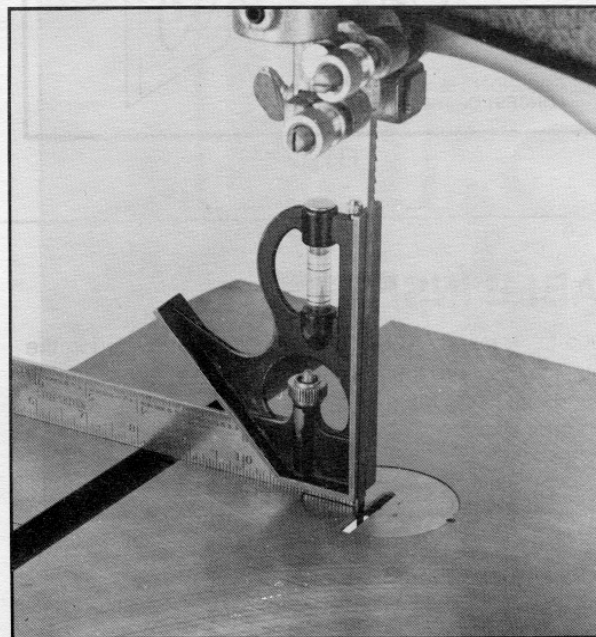

Fig. 22

ADJUSTING BLADE TENSION

On the back of the upper wheel slide bracket there is a series of graduations. These indicate the proper tension for various widths of blades. With the blade on the wheels, turn the knob (A) Fig. 23, to raise or lower the wheel, until the red fiber washer (B) is in line with the proper graduation for the size of blade being used.

The graduations will be found correct for average work, and are not affected by rebrazing of the saw blade. We urge you to use these graduations until you have become familiar enough with the operation of the Band Saw to vary the tension for different kinds of blades or work. Over-straining is a common cause of blade breakage and other unsatisfactory blade performance. Release the tension when the machine is not in use.

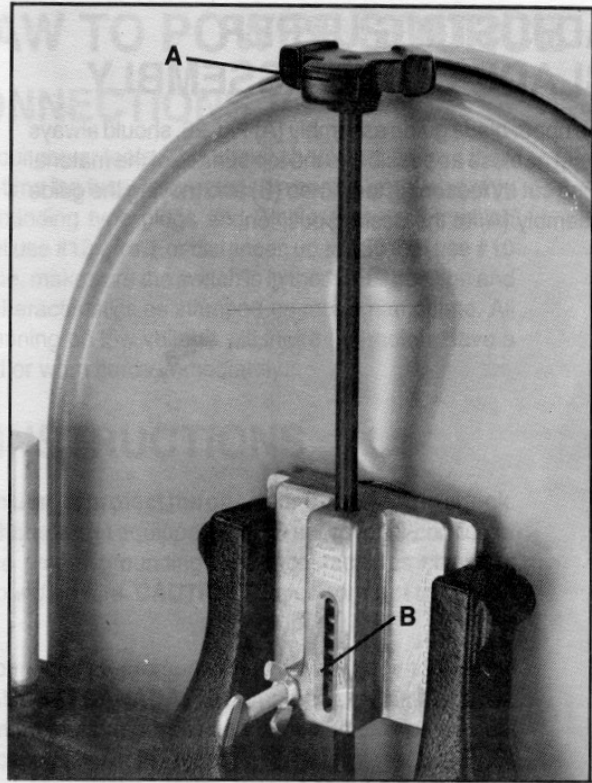

Fig. 23

TRACKING THE BLADE

IMPORTANT: Before tracking the blade, make sure the blade guides and blade support bearings are clear of the blade so as not to interfere with the tracking adjustment.

After tension has been applied to the blade, turn the wheels slowly forward by hand and watch the blade (A) Fig. 24, to see that it travels in the center of the upper tire. If the blade begins to creep toward the front edge, loosen the wing nut (B) Fig. 25, and tighten the thumb screw (C). This will tilt the top of the wheel toward the back of the machine and will draw the blade toward the center of the tire. If the blade creeps toward the back edge, turn the thumb screw in the opposite direction.

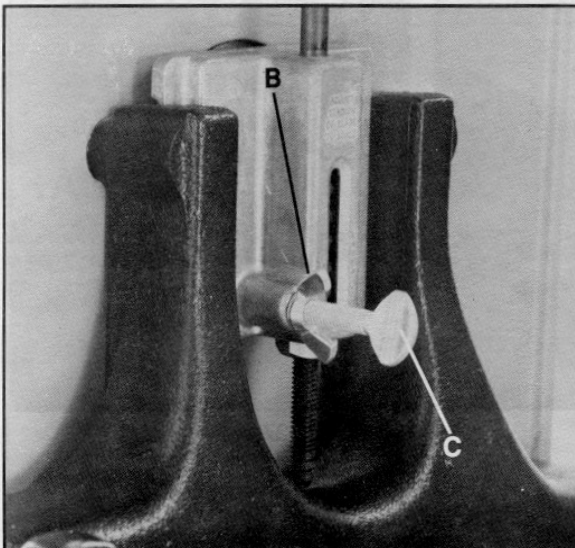

Fig. 25

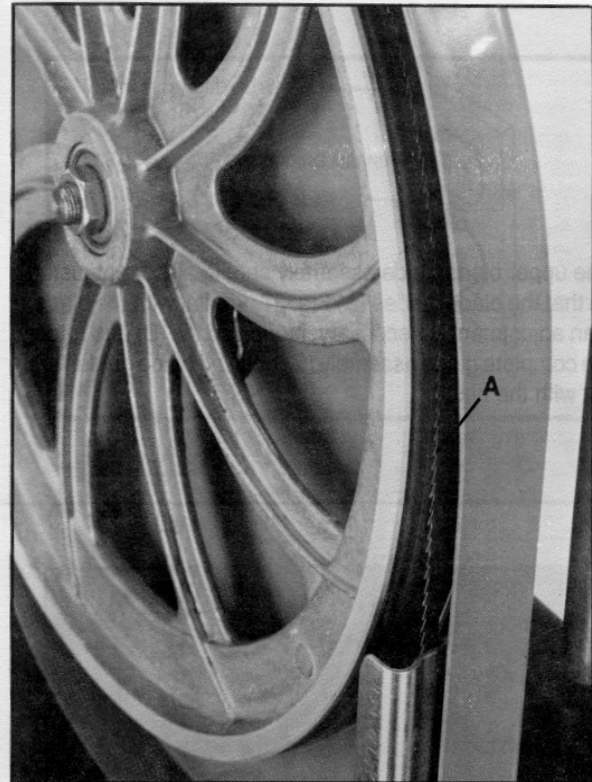

Fig. 24

Adjust the thumb screw (C) Fig. 25, only a fraction of a turn at a time. **NEVER TRACK THE BLADE WHILE THE MACHINE IS RUNNING.** After the blade is tracking in the center of the tires, tighten the wing nut (B) Fig. 25.

ADJUSTING UPPER BLADE GUIDE ASSEMBLY

The upper blade guide assembly (A) Fig. 26, should always be set as close as possible to the top surface of the material being cut by loosening lock knob (B) and moving the guide assembly (A) to the desired position.

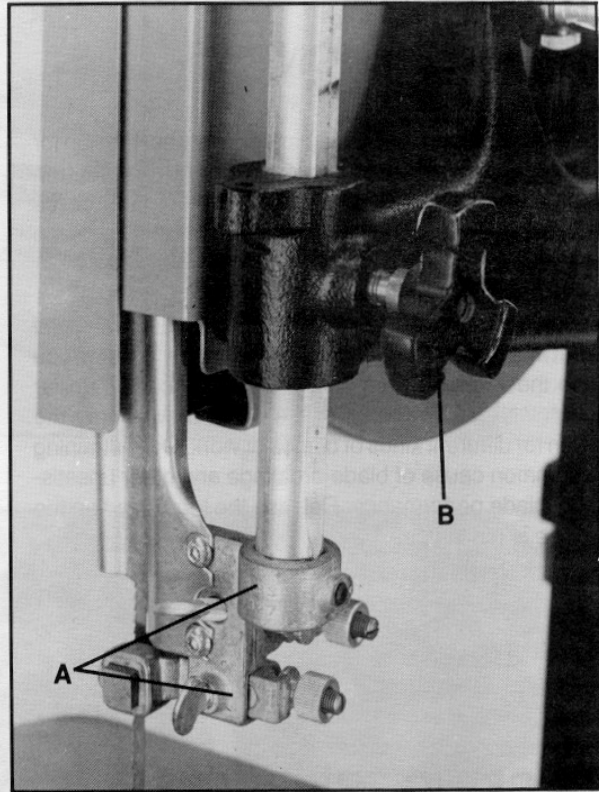

Fig. 26

The upper blade guide assembly should also be adjusted so that the blade guides (A) Fig. 27, are flat with the blade. If an adjustment is necessary, loosen screw (B) and rotate the complete guide assembly (C) until the blade guides are flat with the blade.

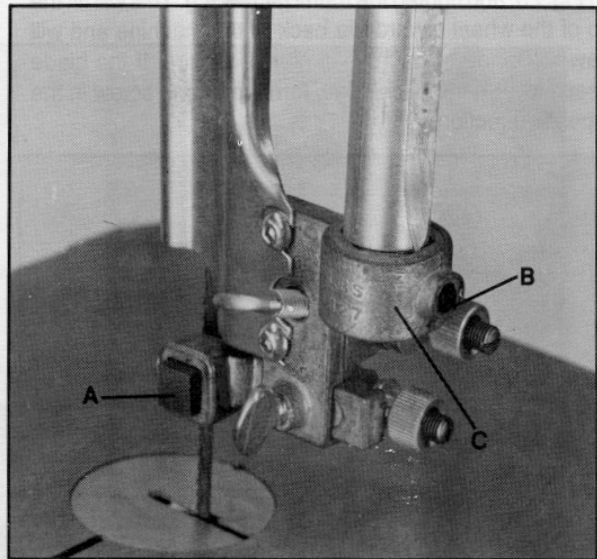

Fig. 27

ADJUSTING UPPER BLADE GUIDES AND BLADE SUPPORT BEARING

The upper blade guides and blade support bearings are adjusted only after the blade is tensioned and tracking properly. To adjust proceed as follows:

1. The upper blade guides (A) Fig. 28, are held in place by means of the set screws (B). Loosen the set screws (B) to move the guides (A) as close as possible to the side of the blade, being careful not to pinch the blade. Then tighten the screws (B).
2. The guides (A) Fig. 28, should then be adjusted so that the front edge of the guides is just behind the "gullets" of the saw teeth. The complete guide block bracket can be moved in or out by loosening thumb screw (C) and turning knurled knob (D) Fig. 28. When guides (A) are set properly, tighten thumb screw (C).
3. The upper blade support bearing (E) Fig. 28, prevents the blade from being pushed too far to the back which could damage the set in the saw teeth. The support bearing (E) should be set $1/64$ " behind the blade by loosening thumb screw (F) and turning knurled knob (G) to move the support bearing (E) in or out.
4. The blade support bearing (E) should also be adjusted so the back edge of the blade overlaps the outside diameter of the ball bearing by about $1/16$ ". The bearing (E) is set on an eccentric and to change position remove screw (H) and bearing (E) Fig. 28. Loosen thumb screw (F), back out screw (G) and reposition shaft that bearing (E) is attached to.

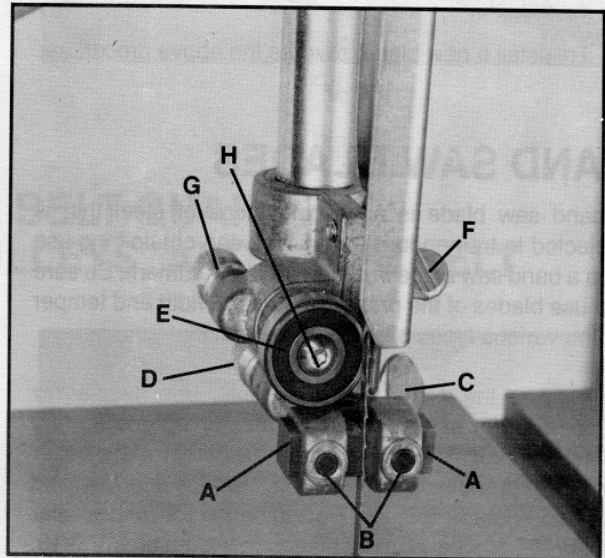

Fig. 28

ADJUSTING LOWER BLADE GUIDES AND BLADE SUPPORT BEARING

The lower blade guides and blade support bearing should be adjusted at the same time as the upper guides and bearing as follows:

1. Loosen the two screws (A) Fig. 29, and move the guides (B) as close as possible to the side of the blade, being careful not to pinch the blade. Then tighten screws (A).
2. The front edge of the guide blocks (B) should be adjusted so they are just behind the "gullets" of the saw teeth by turning the knurled knob (C) Fig. 29.
3. The lower blade support bearing (D) Fig. 29, should be adjusted so it is about $1/64$ " behind the back of the blade by turning the knurled knob (E).

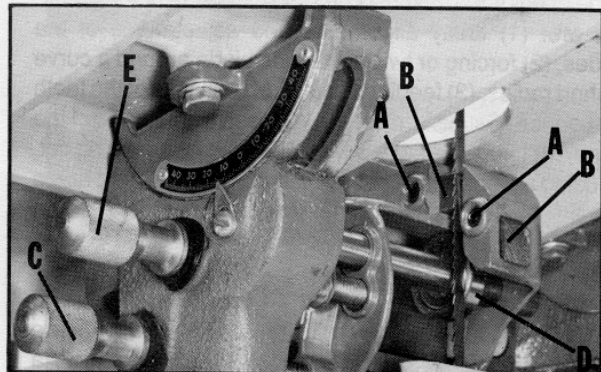

Fig. 29

CHANGING BLADES

To change blades, proceed as follows:

1. Open the upper and lower wheel guards.
2. Release tension on the band saw blade.
3. Remove the table adjustment pin and table insert.
4. Slip the blade off the wheel and guide it out through the slot in the table.
5. To install a new blade, reverse the above procedure.

BAND SAW BLADES

A band saw blade is a delicate piece of steel that is subjected to tremendous strain. You can obtain long use from a band saw blade if you give it fair treatment. Be sure you use blades of the proper thickness, width and temper for the various types of material to be cut.

Always use the widest blade possible. Use the narrow blades only for sawing small, abrupt curves and for fine delicate work. This will save blades and will produce better work. Band saw blades may be purchased, welded, set and sharpened ready for use. For cutting wood and similar materials Delta can supply blades in widths of 1/8, 3/16, 1/4, 3/8, 1/2 and 3/4 inches.

File and set the wood cutting blades whenever you find it requires pressure to make them cut. If a blade is broken it can be brazed or welded; however, if it has become badly work-hardened it will soon break in another place. If you are not equipped to file, set and braze or weld blades, take them to a saw filer for reconditioning.

Any one of a number of conditions may cause a band saw blade to break. Blade breakage is, in some cases, unavoidable, being the natural result of the peculiar stresses to which such blades are subjected. It is, however, often due to avoidable causes, most often to lack of care or judgment on the part of the operator in mounting or adjusting the blade or guides. The most common causes of blade breakage are: (1) faulty alignments and adjustments of the guides, (2) forcing or twisting a wide blade around a curve of short radius, (3) feeding too fast, (4) dullness of the teeth or absence of sufficient set, (5) excessive tightening of the blade, (6) top guide set too high above the work being cut, (7) using a blade with a lumpy or improperly finished braze or weld and, (8) continuous running of the saw blade when not in use for cutting.

New blades for the standard 14 inch Band Saw are 93-1/2 inches long. The adjustment will accommodate blades up to a maximum length of 94 inches and to a minimum length of 91-1/2 inches. When equipped with the No. 28-984 Height Attachment, new blades should be 105 inches long; maximum and minimum lengths are 106 and 103-1/2 inches.

OPERATING THE BAND SAW

Before starting the machine, see that all adjustments are properly made and the guards are in place. Turn the pulley by hand to make sure that everything is correct **BEFORE** turning on the power.

Keep the top guide down close to the work at all times. Do not force the material against the blade too hard. Light contact with the blade will permit easier following of the line and prevent undue friction, heating and work-hardening of the blade at its back edge.

KEEP THE SAW BLADE SHARP and you will find that very little forward pressure is required for average cutting. Move the stock against the blade steadily and no faster than will give an easy cutting movement.

Avoid twisting the blade by trying to turn sharp corners. Remember, you must saw around corners.

CUTTING CURVES

When cutting curves, turn the stock carefully so that the blade may follow without being twisted. If a curve is so abrupt that it is necessary to repeatedly back up and cut a new kerf, either a narrow blade is needed or a blade with more set is required. The more set a blade has, the easier it will allow the stock to be turned, but the cut is usually rougher than where a medium amount of set is used.

In withdrawing the piece being cut, in order to change the cut, or for any other reason, the operator must be careful that he does not accidentally draw the blade off the wheels. In most cases it is easier and safer to turn the stock and saw out through the waste material, rather than try to withdraw the stock from the blade.

PARTS, SERVICE OR WARRANTY ASSISTANCE

All Delta Machines and accessories are manufactured to high quality standards and are serviced by a network of Porter-Cable/Delta Factory Service Centers and Delta Authorized Service Stations. To obtain additional information regarding your Delta quality product or to obtain parts, service, warranty assistance, or the location of the nearest service outlet, please call 1-888-848-5175.



Delta Building Trades and Home Shop Machinery Two Year Limited Warranty

Delta will repair or replace, at its expense and at its option, any Delta machine, machine part, or machine accessory which in normal use has proven to be defective in workmanship or material, provided that the customer returns the product prepaid to a Delta factory service center or authorized service station with proof of purchase of the product within two years and provides Delta with reasonable opportunity to verify the alleged defect by inspection. Delta may require that electric motors be returned prepaid to a motor manufacturer's authorized station for inspection and repair or replacement. Delta will not be responsible for any asserted defect which has resulted from normal wear, misuse, abuse or repair or alteration made or specifically authorized by anyone other than an authorized Delta Service facility or representative. Under no circumstances will Delta be liable for incidental or consequential damages resulting from defective products. This warranty is Delta's sole warranty and sets forth the customer's exclusive remedy, with respect to defective products; all other warranties, express or implied, whether of merchantability, fitness for purpose, or otherwise, are expressly disclaimed by Delta.

PORTER-CABLE • DELTA SERVICE CENTERS (CENTROS DE SERVICIO DE PORTER-CABLE • DELTA)

Parts and Repair Service for Porter-Cable • Delta Machinery are Available at These Locations
(Obtenga Refaccion de Partes o Servicio para su Herramienta en los Siguientes Centros de Porter-Cable • Delta)

ARIZONA

Tempe 85282 (Phoenix)
2400 West Southern Avenue
Suite 105
Phone: (602) 437-1200
Fax: (602) 437-2200

CALIFORNIA

Ontario 91761 (Los Angeles)
3949A East Guasti Road
Phone: (909) 390-5555
Fax: (909) 390-5554

San Leandro 94577 (Oakland)
3039 Teagarden Street
Phone: (510) 357-9762
Fax: (510) 357-7939

COLORADO

Arvada 80003 (Denver)
8175 Sheridan Blvd., Unit S
Phone: (303) 487-1809
Fax: (303) 487-1868

FLORIDA

Davie 33314 (Miami)
4343 South State Rd. 7 (441)
Unit #107
Phone: (954) 321-6635
Fax: (954) 321-6638

Tampa 33609
4538 W. Kennedy Boulevard
Phone: (813) 877-9585
Fax: (813) 289-7948

GEORGIA

Forest Park 30297 (Atlanta)
5442 Frontage Road,
Suite 112
Phone: (404) 608-0006
Fax: (404) 608-1123

ILLINOIS

Addison 60101 (Chicago)
400 South Rohlwing Rd.
Phone: (630) 424-8805
Fax: (630) 424-8895

Woodridge 60517 (Chicago)
2033 West 75th Street
Phone: (630) 910-9200
Fax: (630) 910-0360

MARYLAND

Elkridge 21075 (Baltimore)
7397-102 Washington Blvd.
Phone: (410) 799-9394
Fax: (410) 799-9398

MASSACHUSETTS

Braintree 02185 (Boston)
719 Granite Street
Phone: (781) 848-9810
Fax: (781) 848-6759

Franklin 02038 (Boston)
Franklin Industrial Park
101E Constitution Blvd.
Phone: (508) 520-8802
Fax: (508) 528-8089

MICHIGAN

Madison Heights 48071 (Detroit)
30475 Stephenson Highway
Phone: (248) 597-5000
Fax: (248) 597-5004

MINNESOTA

Minneapolis 55429
5522 Lakeland Avenue North
Phone: (763) 561-9080
Fax: (763) 561-0653

MISSOURI

North Kansas City 64116
1141 Swift Avenue
Phone: (816) 221-2070
Fax: (816) 221-2897

St. Louis 63119
7574 Watson Road
Phone: (314) 968-8950
Fax: (314) 968-2790

NEW YORK

Flushing 11365-1595 (N.Y.C.)
175-25 Horace Harding Expwy.
Phone: (718) 225-2040
Fax: (718) 423-9619

NORTH CAROLINA

Charlotte 28270
9129 Monroe Road, Suite 115
Phone: (704) 841-1176
Fax: (704) 708-4625

OHIO

Columbus 43214
4560 Indianola Avenue
Phone: (614) 263-0929
Fax: (614) 263-1238

Cleveland 44125
8001 Sweet Valley Drive
Unit #19
Phone: (216) 447-9030
Fax: (216) 447-3097

OREGON

Portland 97230
4916 NE 122 nd Ave.
Phone: (503) 252-0107
Fax: (503) 252-2123

PENNSYLVANIA

Willow Grove 19090
520 North York Road
Phone: (215) 658-1430
Fax: (215) 658-1433

TEXAS

Carrollton 75006 (Dallas)
1300 Interstate 35 N, Suite 112
Phone: (972) 446-2996
Fax: (972) 446-8157

Houston 77038
4321 Sam Houston Parkway,
West
Suite 180
Phone: (281) 260-8887
Fax: (281) 260-9989

WASHINGTON

Auburn 98001 (Seattle)
3320 West Valley HWY, North
Building D, Suite 111
Phone: (253) 333-8353
Fax: (253) 333-9613

Authorized Service Stations are located in many large cities. Telephone **800-438-2486** or **731-541-6042** for assistance locating one. Parts and accessories for Porter-Cable-Delta products should be obtained by contacting any Porter-Cable-Delta Distributor, Authorized Service Center, or Porter-Cable-Delta Factory Service Center. If you do not have access to any of these, call **800-223-7278** and you will be directed to the nearest Porter-Cable-Delta Factory Service Center. Las Estaciones de Servicio Autorizadas están ubicadas en muchas grandes ciudades. Llame al **800-438-2486** ó al **731-541-6042** para obtener asistencia a fin de localizar una. Las piezas y los accesorios para los productos Porter-Cable-Delta deben obtenerse poniéndose en contacto con cualquier distribuidor Porter-Cable-Delta, Centro de Servicio Autorizado o Centro de Servicio de Fábrica Porter-Cable-Delta. Si no tiene acceso a ninguna de estas opciones, llame al **800-223-7278** y le dirigirán al Centro de Servicio de Fábrica Porter-Cable-Delta más cercano.

CANADIAN PORTER-CABLE • DELTA SERVICE CENTERS

ALBERTA

Bay 6, 2520-23rd St. N.E.
Calgary, Alberta
T2E 8L2
Phone: (403) 735-6166
Fax: (403) 735-6144

BRITISH COLUMBIA

8520 Baxter Place
Burnaby, B.C.
V5A 4T8
Phone: (604) 420-0102
Fax: (604) 420-3522

MANITOBA

1699 Dublin Avenue
Winnipeg, Manitoba
R3H 0H2
Phone: (204) 633-9259
Fax: (204) 632-1976

ONTARIO

505 Southgate Drive
Guelph, Ontario
N1H 6M7
Phone: (519) 767-4132
Fax: (519) 767-4131

QUÉBEC

1515 ave.
St-Jean Baptiste, Suite 160
Québec, Québec
G2E 5E2
Phone: (418) 877-7112
Fax: (418) 877-7123

1447, Begin
St-Laurent, (Montréal),
Québec
H4R 1V8
Phone: (514) 336-8772
Fax: (514) 336-3505

The following are trademarks of PORTER-CABLE-DELTA (Las siguientes son marcas registradas de PORTER-CABLE S.A.): Auto-Set®, BAMMER®, B.O.S.S.®, Builder's Saw®, Contractor's Saw®, Contractor's Saw II™, Delta®, DELTACRAFT®, DELTAGRAM™, Delta Series 2000™, DURATRONIC™, Emc2™, FLEX®, Flying Chips™, FRAME SAW®, Homecraft®, INNOVATION THAT WORKS®, Jet-Lock®, JETSTREAM®, 'kickstand®, LASERLOC®, MICRO-SET®, Micro-Set®, MIDI LATHE®, MORTEN™, NETWORK™, OMNIJIG®, POCKET CUTTER®, PORTA-BAND®, PORTA-PLANE®, PORTER-CABLE®&(design), PORTER-CABLE®PROFESSIONAL POWER TOOLS, Posi-Matic®, Q-3®&(design), QUICKSAND®&(design), QUICKSET™, QUICKSET II®, QUICKSET PLUS™, RIPTIDE™&(design), SAFE GUARD II®, SAFE-LOC®, Sanding Center®, SANDTRAP®&(design), SAW BOSS®, Sawbuck™, Sidekick®, SPEEDMATIC®, SPEED-BLOC®, SPEEDTRONIC®, STAIR EASE®, The American Woodshop®&(design), The Lumber Company®&(design), THE PROFESSIONAL EDGE®, THE PROFESSIONAL SELECT®, THIN-LINE™, TIGER®, TIGER CUB®, TIGER SAW®, TORQBUSTER®, TORQ-BUSTER®, TRU-MATCH™, TWIN-LITE®, UNIGUARD®, Unifence®, UNIFEEDER™, Unihead®, Uniplane™, Unirip®, Unisaw®, Univise®, Versa-Feeder®, VERSA-PLANE®, WHISPER SERIES®, WOODWORKER'S CHOICE™.

Trademarks noted with ™ and ® are registered in the United States Patent and Trademark Office and may also be registered in other countries. Las Marcas Registradas con el signo de ™ y ® son registradas por la Oficina de Registros y Patentes de los Estados Unidos y también pueden estar registradas en otros países.

Printed in U.S.A.